



Stampa

PRICE LIST  
Jan. 2008



## STAMPA Collection

### Form meets Function

Stampa, a multi-functional, unified storage system.

Wherever storage is needed, from basic metal back-office to elegant wood and glass public areas.

Combine Metal, Wood, PVC and Glass in simple, cohesive harmony.

Mix and Match; From Elegant to Simple.

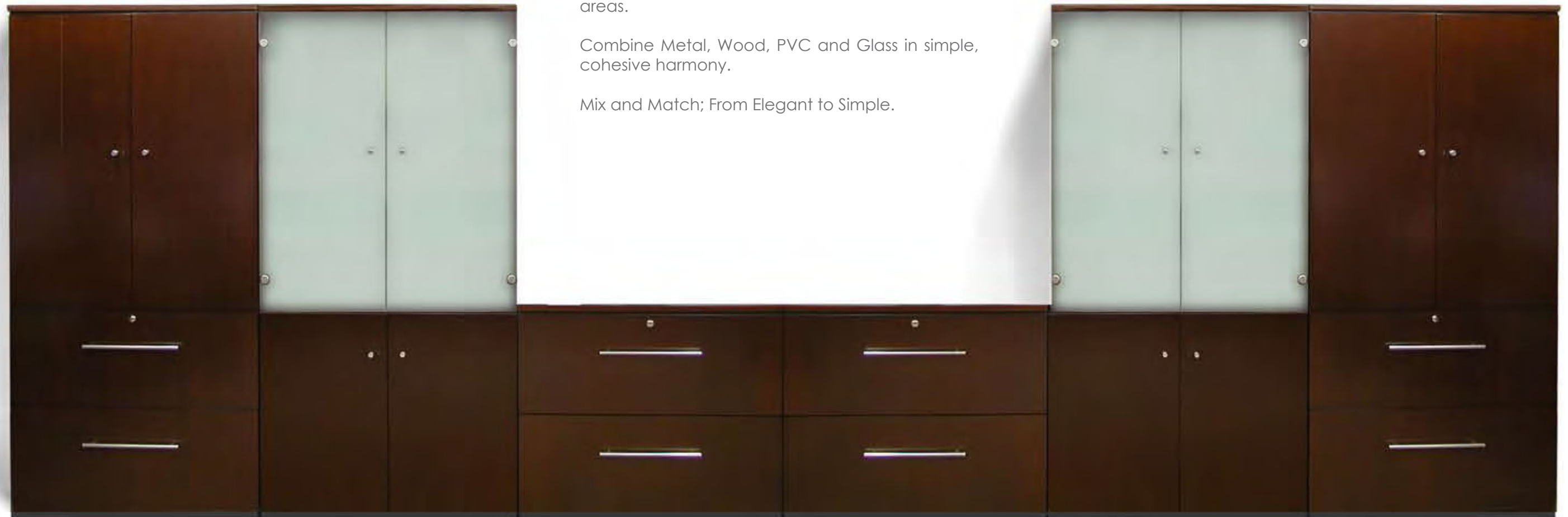

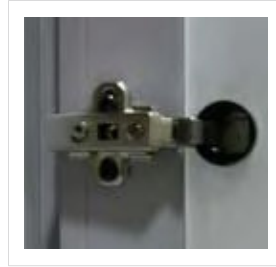

STAMPA Collection



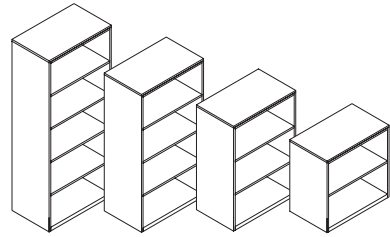

**S7131**  
Open bookcase

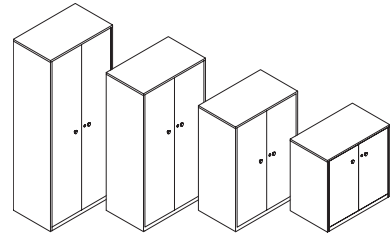

**S7133**  
Bookcase with hinged doors

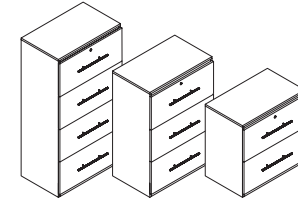

**S7136**  
Lateral files

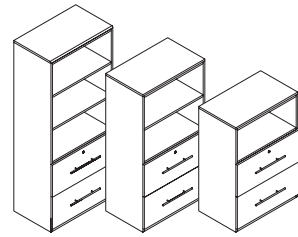

**S7135**  
Bookcase with 2 file drawers

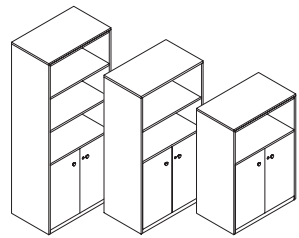

**S7132**  
Storage / bookcase cabinet

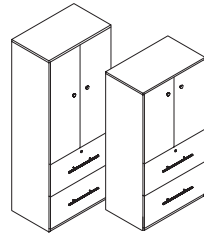

**S7137**  
Storage cabinet with 2 file drawers

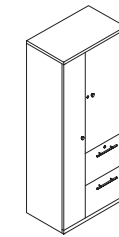

**S7150**  
Split storage / wardrobe cabinet / file, file

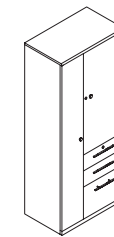

**S7151**  
Split storage / wardrobe cabinet / box, box, file



**S7160**  
Split storage / wardrobe cabinet / file

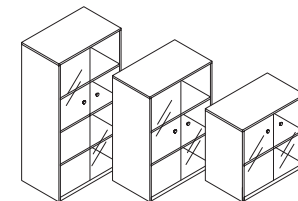

**S7143**  
Bookcase with glass doors

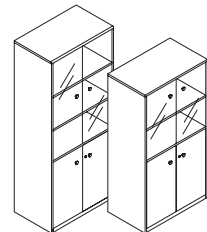

**S7144**  
Storage / bookcase with glass doors

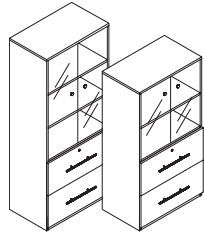

**S7147**  
Storage cabinet with glass doors / 2 file drawers

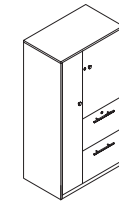

**S7155**  
Split storage / wardrobe cabinet / file, file

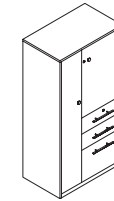

**S7156**  
Split storage / wardrobe cabinet / box, box, file

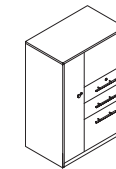

**S7157**  
Split storage / wardrobe cabinet / box, box, file / left



**S7158**  
Split storage / wardrobe cabinet / box, box, file / right

**S7131**  
page 8

**S7132**  
page 9

**S7133**  
page 10

**S7135**  
page 11

**S7136**  
page 12

**S7137**  
page 13

**S7143**  
page 14

**S7144**  
page 15

**S7147**  
page 16

**S7150**  
page 17

**S7151**  
page 18

**S7155**  
page 19

**S7156**  
page 20

**S7157**  
page 21

**S7158**  
page 22

**S7160**  
page 23

# Finishes

## METAL

Tops, body, shelves, doors, drawer fronts.

S301	Aluminum
S302	Platinum
S303	Medium gray
S304	Oxford gray
S305	Black
S306	Almond
S307	Sand
S308	Silver
S309	Smoke
S310	Steel gray

## PVC

Tops, doors, drawer fronts.

M101	Platinum
M103	Almond
M104	Sand
M105	Smoke
M106	Steel
M111	Crystal white
B102	Black

## VENEER

Tops, doors, drawer fronts.

Z203	English cherry
Z204	Medium cherry
Z205	Biedermeier cherry
Z213	Natural maple
Z214	Cocoa on walnut
Z220	Natural beech

## GLASS

Doors.

A912	Translucent glass (sandblasted)
------	---------------------------------

## TOP EDGE



**SQ** SQUARE

## PULL TYPE

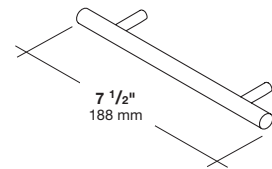

**Description**  
Width: 7 1/2" (188 mm)  
Diameter: 1/2" (12.7 mm)  
Finish: polished aluminum

For box and file drawers.

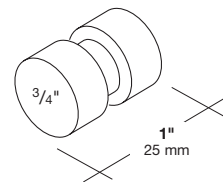
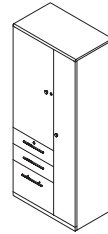

**Description**  
Deep: 1" (25 mm)  
Diameter: 3/4" (17 mm)  
Finish: polished aluminum

For blind doors and glass doors.

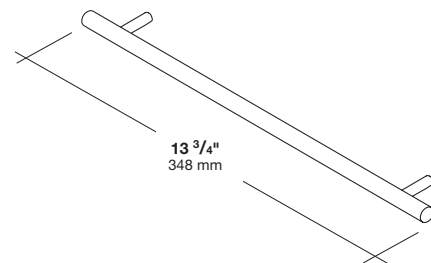
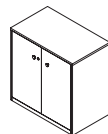

**Description**  
Width: 13 3/4" (348 mm)  
Diameter: 1/2" (12.7 mm)  
Finish: polished aluminum

For lateral file drawers.

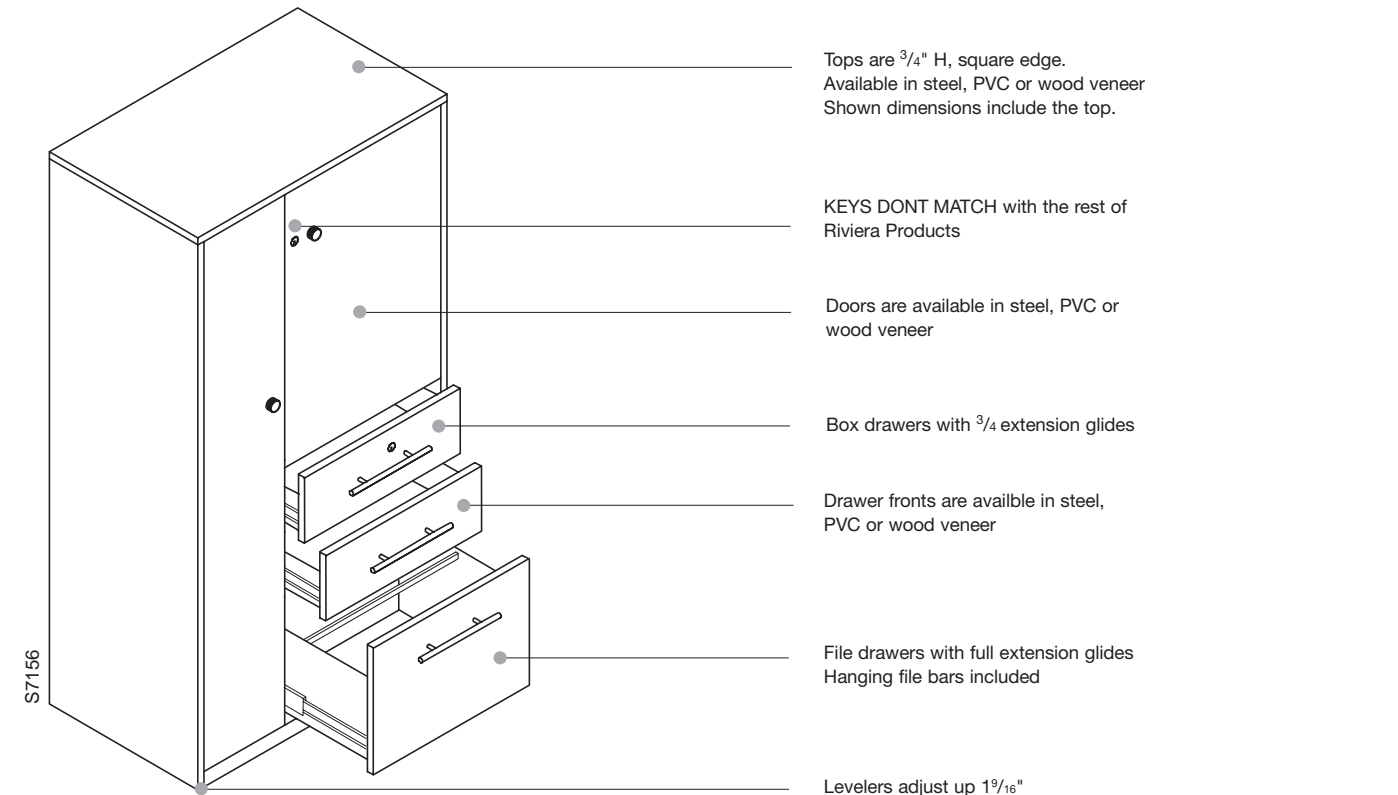

Tops are 3/4" H, square edge.  
Available in steel, PVC or wood veneer  
Shown dimensions include the top.

KEYS DONT MATCH with the rest of Riviera Products

Doors are available in steel, PVC or wood veneer

Box drawers with 3/4 extension glides

Drawer fronts are available in steel, PVC or wood veneer

File drawers with full extension glides  
Hanging file bars included

Levelers adjust up 19/16"

S7156

Translucent glass (sandblasted)  
Glass doors locks not available

Adjustable shelves can be positioned each 1/4"  
Available only in steel

KEYS DONT MATCH with the rest of Riviera Products

Lateral file drawers with full extension glides  
Hanging file bars included

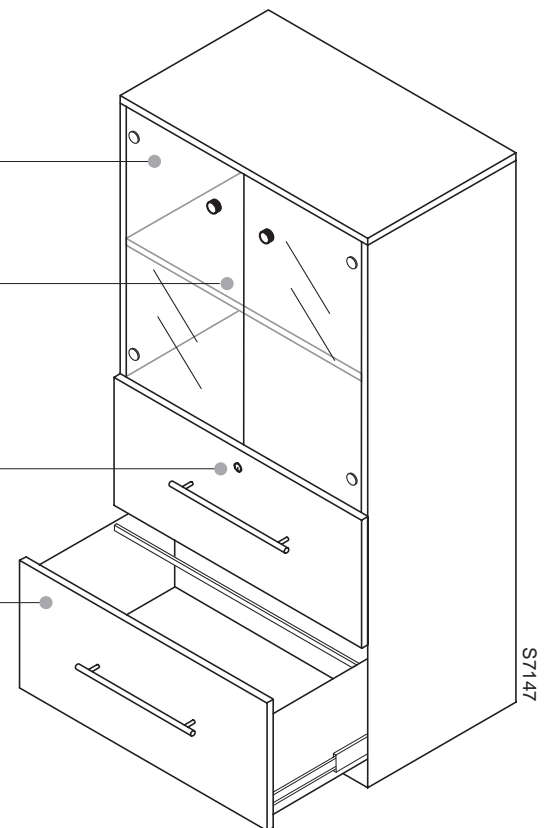

S7147

Width: 30" / 36" Deep: 18"

Width: 30" Deep: 24"

	S7131	S7132	S7133	S7135	S7136	S7137	S7143	S7144	S7147
30" 763 mm									
44" 1115 mm									
58" 1467 mm									
72" 1819 mm									

S7150	S7151	S7155	S7156	S7157	S7158	S7160

NOTE: nominal measurements

# S7131

## Open bookcase

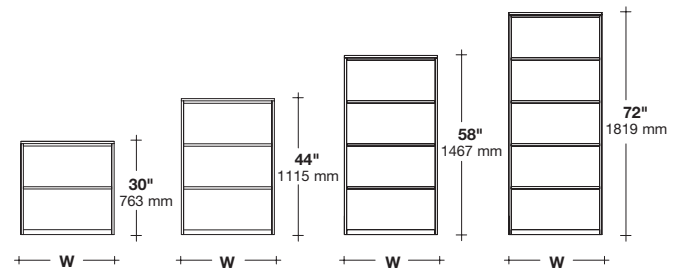
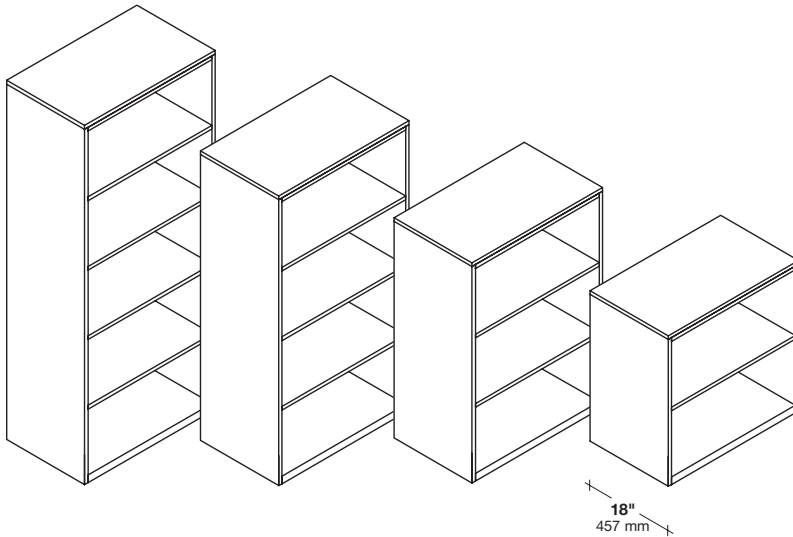

CODE	W	H	TOP	BODY / SHELVES	STEEL	VEENER	PVC
S7131	30	30	STEEL	S301	\$ 550	\$ 583	\$ 607
	30	44	S301	S302	713	747	770
	30	58	S303	S303	877	910	933
	30	72	S304	S304	1,033	1,063	1,090
			S305	S305			
	36	30	S306	S306	607	643	673
	36	44	S307	S307	787	827	853
	36	58	S308	S308	960	997	1,027
	36	72			1,130	1,170	1,197
			VEENER				
			Z203				
			Z204				
		Z205					
		Z213					
		Z214					
		Z220					
		PVC					
		M101					
		M103					
		M104					
		M105					
		M106					
		B102					

### Description

- 30" H: 1 adjustable shelf
- 44" H: 1 fixed shelf, 1 adjustable shelf
- 58" H: 1 fixed shelf, 2 adjustable shelves
- 72" H: 1 fixed shelf, 3 adjustable shelves

### Specifications

- Tops are  $\frac{3}{4}$ " H, square edge.
- Adjustable shelves can be positioned each  $\frac{1}{4}$ "
- Levelers adjust up  $\frac{1}{16}$ "

### Finishes

Please specify top finish and body color.

EXAMPLE

S7131 3030 Z214 S301

# S7132

## Storage / Bookcase cabinet

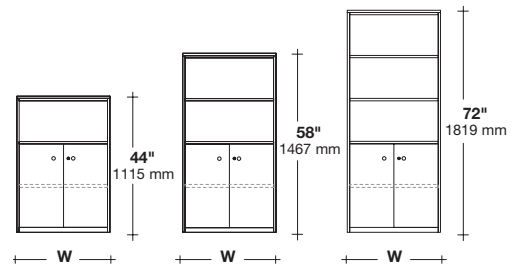
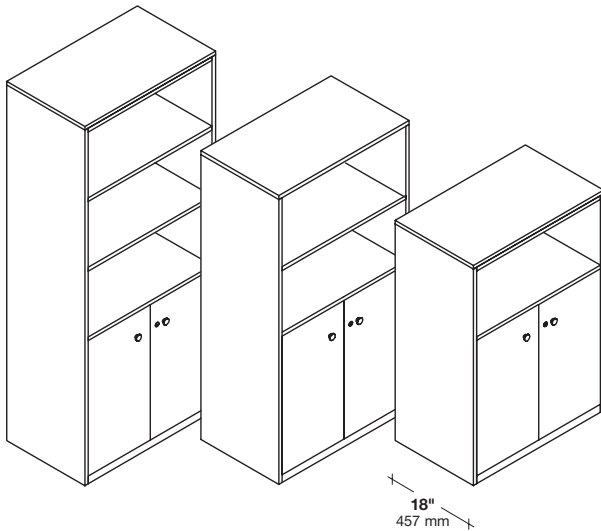

CODE	W	H	TOP / DOORS	BODY / SHELVES	STEEL	VEENER	PVC
<b>S7132</b>			STEEL				
			S301	S301	\$ 1,000	\$ 1,080	\$ 1,270
	30	44	S302	S302	1,160	1,240	1,433
	30	72	S303	S303	1,317	1,397	1,590
			S304	S304			
	36	44	S305	S305	1,087	1,180	1,400
	36	58	S306	S306	1,257	1,350	1,570
	36	72	S307	S307	1,430	1,523	1,743
			S308	S308			
			VEENER				
			Z203				
			Z204				
			Z205				
			Z213				
		Z214					
		Z220					
		PVC					
		M101					
		M103					
		M104					
		M105					
		M106					
		B102					

### Description

44" H: 1 adjustable shelf  
 58" H: 2 adjustable shelves  
 72" H: 3 adjustable shelves  
 2 hinged doors with lock

### Specifications

Tops are 3/4" H, square edge.  
 Adjustable shelves can be positioned each 1 1/4"  
 Levelers adjust up 1 9/16"

### Finishes

Please specify top finish and body color.

EXAMPLE

**S7132 3044 Z214 S301**



# S7133

## Bookcase with hinged doors

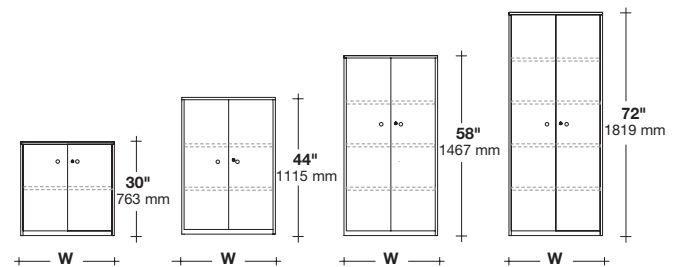
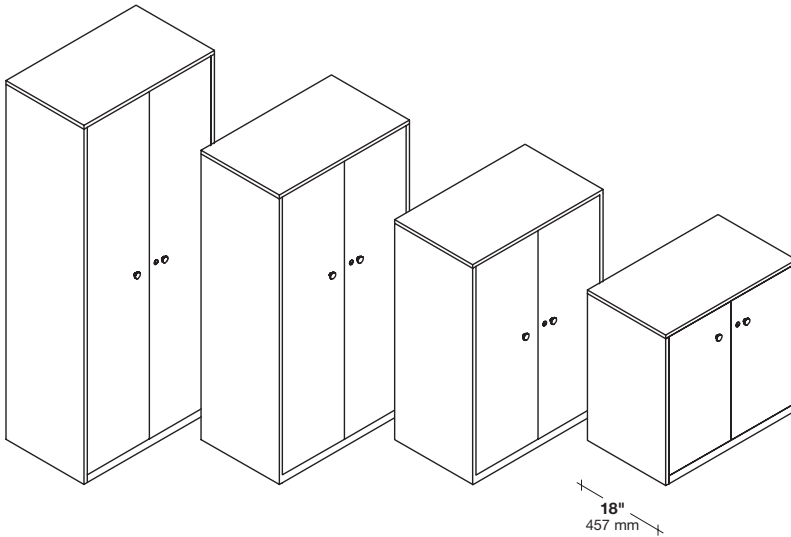

CODE	W	H	TOP / DOORS	BODY / SHELVES	STEEL	VEENER	PVC
S7133	30	30	STEEL		\$	\$	\$
			S301	S301	837	913	1,107
	30	44	S302	S302	1,050	1,143	1,403
	30	58	S303	S303	1,287	1,393	1,720
	30	72	S304	S304	1,493	1,617	2,010
			S305	S305			
	36	30	S306	S306	903	997	1,217
	36	44	S307	S307	1,143	1,257	1,550
	36	58	S308	S308	1,393	1,530	1,897
	36	72			1,623	1,780	2,223
			VEENER				
			Z203				
		Z204					
		Z205					
		Z213					
		Z214					
		Z220					
		PVC					
		M101					
		M103					
		M104					
		M105					
		M106					
		B102					

### Description

30" H: 1 adjustable shelf  
 44" H: 1 fixed shelf, 1 adjustable shelf  
 58" H: 1 fixed shelf, 2 adjustable shelves  
 72" H: 1 fixed shelf, 3 adjustable shelves  
 2 hinged doors with lock

### Specifications

Tops are  $\frac{3}{4}$ " H, square edge.  
 Adjustable shelves can be positioned each  $\frac{1}{4}$ "  
 Levelers adjust up  $\frac{19}{16}$ "

### Finishes

Please specify top and doors finishes and body color.

EXAMPLE

S7133 3030 Z214 S301

# S7135

## Bookcase with 2 file drawers

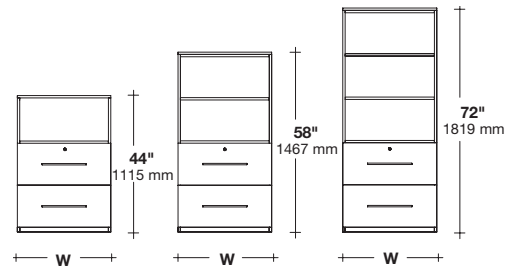
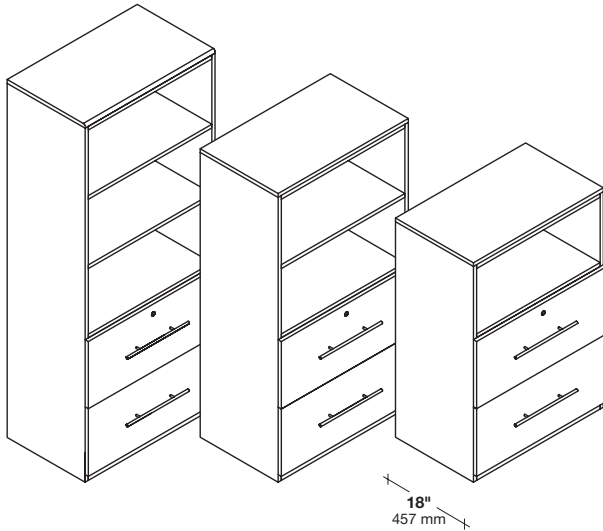

CODE	W	H	TOP AND		STEEL	VENEER	PVC
			DRAWER FRONTS	BODY / SHELVES			
S7135	30	44	STEEL				
			S301	S301	\$ 1,667	\$ 1,710	\$ 1,780
			S302	S302	\$ 1,827	\$ 1,873	\$ 1,943
			S303	S303	\$ 1,990	\$ 2,033	\$ 2,103
	36	44	S304	S304			
			S305	S305	\$ 1,787	\$ 1,837	\$ 1,917
			S306	S306	\$ 1,967	\$ 2,013	\$ 2,093
			S307	S307	\$ 2,143	\$ 2,190	\$ 2,270
		72	S308	S308			
			VENEER				
			Z203				
			Z204				
			Z205				
			Z213				
			Z214				
			Z220				
			PVC				
			M101				
			M103				
			M104				
			M105				
			M106				
B102							

EXAMPLE

S7135 3044 Z214 S301

### Description

58" H: 1 adjustable shelf  
 72" H: 2 adjustable shelves  
 2 lateral file drawers with lock

### Specifications

Tops are 3/4" H, square edge  
 Adjustable shelves can be positioned each 1/4"  
 Levelers adjust up 19/16"  
 File drawers with full extension glides  
 Hanging file bars included

### Finishes

Please specify top finish and color body.

# S7136

## Lateral files

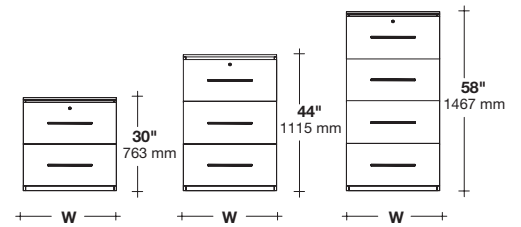
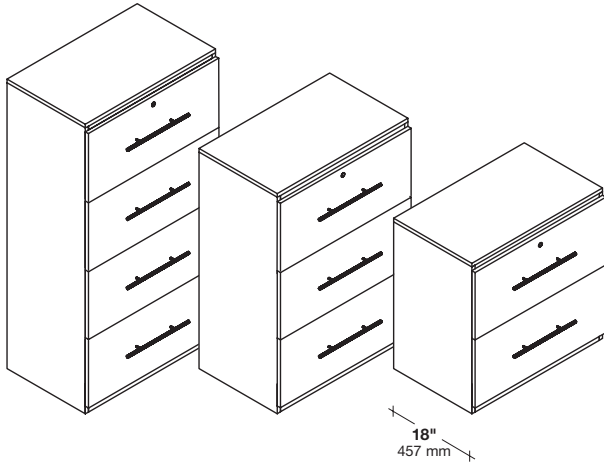

CODE	W	H	TOP AND		STEEL	VENEER	PVC
			DRAWERS FRONT	BODY			
<b>S7136</b>	<b>30</b>	<b>30</b>	STEEL		\$	\$	\$
			S301	S301	1,503	1,547	1,617
			S302	S302	2,010	2,050	2,147
	<b>30</b>	<b>44</b>	S303	S303	2,533	2,557	2,680
			S304	S304			
	<b>36</b>	<b>30</b>	S305	S305	1,607	1,653	1,733
			S306	S306	2,147	2,193	2,303
	<b>36</b>	<b>58</b>	S307	S307	2,693	2,733	2,870
			S308	S308			
			VENEER				
				Z203			
				Z204			
			Z205				
			Z213				
			Z214				
			Z220				
			PVC				
			M101				
			M103				
			M104				
			M105				
			M106				
			B102				

### Description

File drawers with lock

### Specifications

Tops are 3/4" H, square edge  
 Levelers adjust up 1 9/16"  
 File drawers with full extension glides  
 Hanging file bars included

### Finishes

Please specify top finish and body color.

EXAMPLE

**S7136 3030 Z214 S301**

# S7137

## Storage cabinet with 2 file drawers

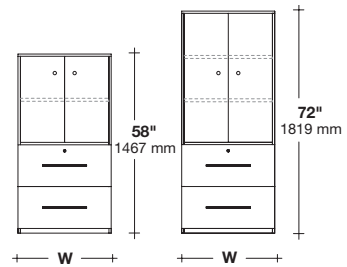
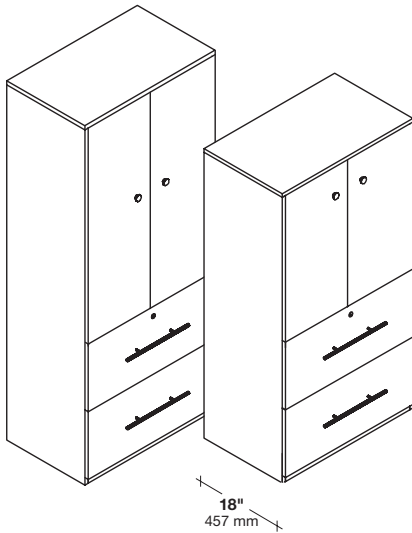

CODE	TOP / DOORS		DRAWER FRONTS	BODY / SHELVES	STEEL	VENEER	PVC
	W	H					
<b>S7137</b>	<b>30</b>	<b>58</b>	STEEL	S301	\$ 2,113	\$ 2,193	\$ 2,443
		<b>72</b>	S302	S302	2,327	2,423	2,737
			S303	S303			
	<b>36</b>	<b>58</b>	S304	S304	2,263	2,360	2,640
		<b>72</b>	S305	S305	2,500	2,673	2,970
			S306	S306			
			S307	S307			
			S308	S308			
		VEENER					
		Z203					
		Z204					
		Z205					
		Z213					
		Z214					
		Z220					
		PVC					
		M101					
		M103					
		M104					
		M105					
		M106					
		B102					

EXAMPLE

**S7137 3058 Z214 S301**

### Description

58" H: 1 adjustable shelf  
 72" H: 2 adjustable shelves  
 2 hinged doors with lock  
 2 lateral file drawers with lock

### Specifications

Tops are 3/4" H, square edge  
 Adjustable shelves can be positioned each 1 1/4"  
 Levelers adjust up 1 9/16"  
 File drawers with full extension glides  
 Hanging file bars included

### Finishes

Please specify top, doors and drawer fronts finishes and body color.

# S7143

## Bookcase with glass doors

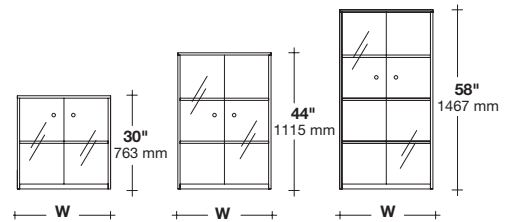
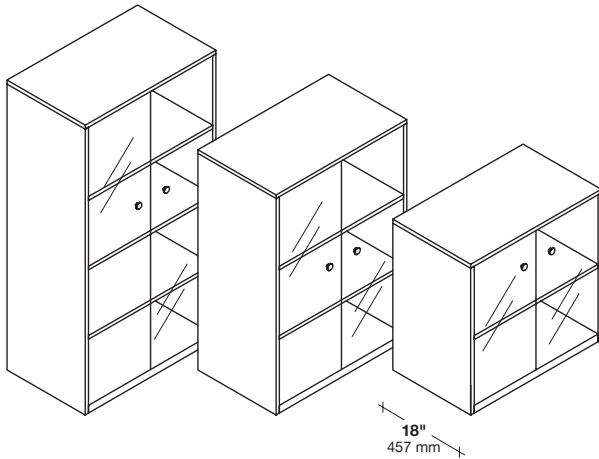

CODE	W	H	TOP	BODY	DOORS	STEEL	VENEER	PVC
S7143	30	30	STEEL	S301	A912	\$	\$	\$
			S302			1,187	1,220	1,243
	30	44	S303	S302	1,493	1,527	1,550	
			S304	S303	1,917	1,950	1,973	
	36	30	S305	S304				
			S305	S305	1,297	1,337	1,363	
	36	44	S306	S305				
			S306	S306	1,647	1,687	1,713	
	36	58	S307	S306				
			S307	S307	2,107	2,147	2,173	
			S308	S307				
			S308	S308				
			VEENER					
		Z203						
		Z204						
		Z205						
		Z213						
		Z214						
		Z220						
		PVC						
		M101						
		M103						
		M104						
		M105						
		M106						
		B102						

### Description

30" H: 1 adjustable shelf  
 44" H: 1 fixed shelf, 1 adjustable shelf  
 58" H: 1 fixed shelf, 2 adjustable shelves  
 Translucent glass doors

### Specifications

Tops are  $\frac{3}{4}$ " H, square edge.  
 Adjustable shelves can be positioned each  $\frac{1}{4}$ "  
 Levelers adjust up  $\frac{9}{16}$ "  
 Glass door locks NOT available

### Finishes

Please specify top finish and body color.

### Note

No locks available.

EXAMPLE

S7143 3030 Z214 S301 A912

# S7144

## Storage / Bookcase with glass doors

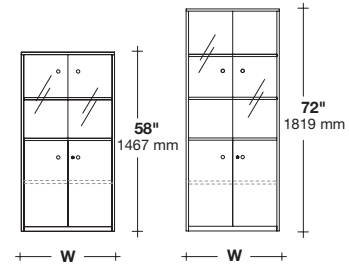
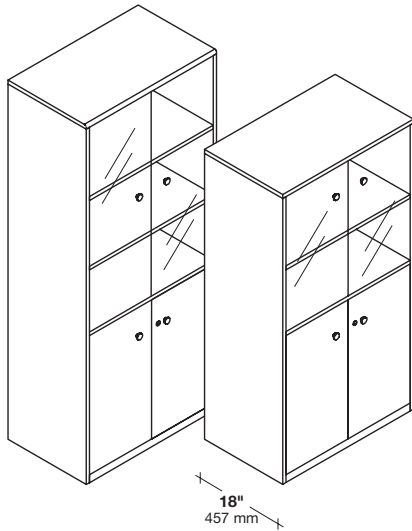

CODE	W	H	TOP / DOORS	BODY	DOORS	STEEL	VEENER	PVC			
<b>S7144</b>	<b>30</b>	<b>58</b>	STEEL	S301	<b>A912</b>	<b>\$ 1,797</b>	<b>\$ 1,877</b>	<b>\$ 2,070</b>			
		<b>72</b>	S302	S302		<b>2,097</b>	<b>2,173</b>	<b>2,367</b>			
	<b>36</b>	<b>58</b>	S303	S303		<b>1,950</b>	<b>2,043</b>	<b>2,263</b>			
		<b>72</b>	S304	S304							
	S305	S305	<b>2,290</b>	<b>2,380</b>					<b>2,603</b>		
	S306	S306									
	S307	S307									
	S308	S308									
	VEENER			Z203							
				Z204							
			Z205								
			Z213								
			Z214								
			Z220								
PVC			M101								
			M103								
			M104								
			M105								
			M106								
			B102								

### Description

58" H: 2 adjustable shelves  
 72" H: 3 adjustable shelves  
 Translucent glass doors

### Specifications

Tops are 3/4" H, square edge.  
 Adjustable shelves can be positioned each 1 1/4"  
 Levelers adjust up 1 9/16"  
 Glass door locks NOT available

### Finishes

Please specify top and doors finishes and body color.

EXAMPLE

**S7144 3058 Z214 S301 A912**

# S7147

## Storage cabinet with glass doors / 2 file drawers

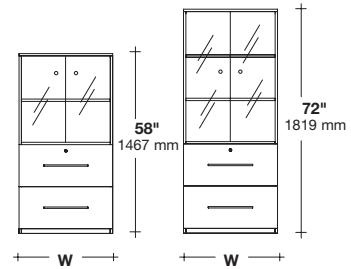
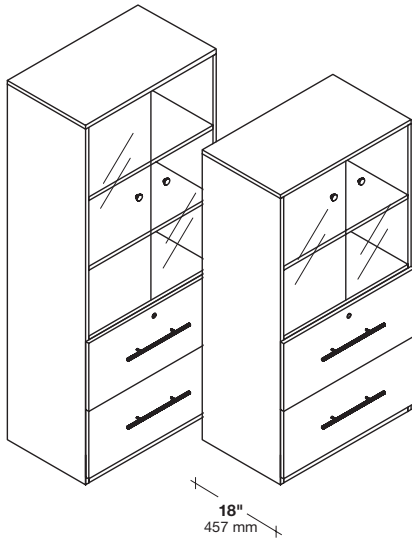

CODE	TOP AND		DRAWER FRONTS	BODY / SHELVES	DOORS	STEEL	VENEER	PVC
	W	H						
S7147	30	58	STEEL S301	S301	A912	\$	\$	\$
		72	S302	S302		2,463	2,510	2,580
	36	58	S303	S303	A912	2,657	2,703	2,783
		72	S304	S304				
	36	58	S305	S305	A912	3,000	3,050	3,130
		72	S306	S306				
	36	58	S307	S307	A912	3,000	3,050	3,130
		72	S308	S308				
				VENEER				
				Z203				
				Z204				
				Z205				
				Z213				
				Z214				
			Z220					
			PVC					
			M101					
			M103					
			M104					
			M105					
			M106					
			B102					

### Description

58" H: 1 adjustable shelf  
 72" H: 2 adjustable shelves  
 2 lateral file drawers with lock  
 Translucent glass doors

### Specifications

Tops are 3/4" H, square edge  
 Adjustable shelves can be positioned each 1 1/4"  
 Levelers adjust up 1 9/16"  
 File drawers with full extension glides  
 Hanging file bars included  
 Glass door locks NOT available

### Finishes

Please specify top finish and body color.

EXAMPLE

S7147 3058 Z214 S301 A912

# S7150

## Split Storage / wardrobe cabinet / file, file

72" H

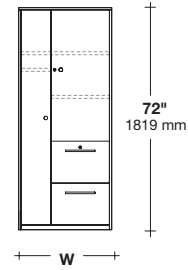
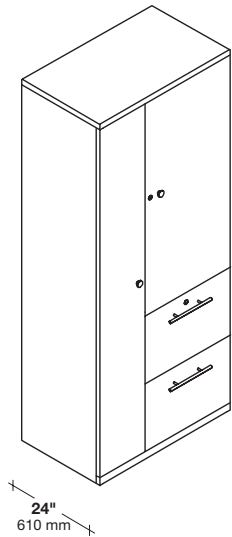

CODE	W	H	TOP / DOORS			STEEL	VENEER	PVC
			DRAWER FRONTS	BODY / SHELVES				
S7150	30	72		STEEL		\$	\$	\$
			S301	S301	2,470	2,700	3,237	
			S302	S302				
			S303	S303				
			S304	S304				
			S305	S305				
			S306	S306				
			S307	S307				
			S308	S308				
				VEENER				
			Z203					
			Z204					
			Z205					
			Z213					
			Z214					
			Z220					
				PVC				
			M101					
M103								
M104								
M105								
M106								
B102								

EXAMPLE

S7150 3072 Z214 S301

### Description

2 hinged doors with lock  
Coat rod on wardrobe side  
Closed section with 1 adjustable shelf  
2 file drawers with lock

### Specifications

Tops are  $\frac{3}{4}$ " H, square edge.  
Adjustable shelves can be positioned each  $1\frac{1}{4}$ "  
Levelers adjust up  $1\frac{9}{16}$ "  
File drawers with full extension glides  
Hanging file bars included

### Finishes

Please specify top finish and body color.



# S7151

## Split Storage / wardrobe cabinet / box, box, file

72" H

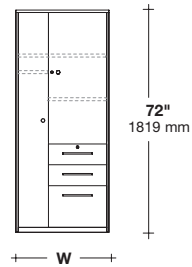
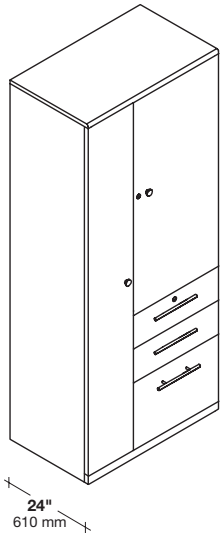

CODE	TOP / DOORS		DRAWER FRONTS	BODY / SHELVES	STEEL	VENEER	PVC	
	W	H						
S7151	30	72	STEEL		\$	\$	\$	
			S301	S301	2,527	2,757	3,320	
			S302	S302				
			S303	S303				
			S304	S304				
			S305	S305				
			S306	S306				
			S307	S307				
			S308	S308				
			VEENER					
			Z203					
			Z204					
			Z205					
			Z213					
			Z214					
			Z220					
			PVC					
M101								
M103								
M104								
M105								
M106								
B102								

### Description

2 hinged doors with lock  
 Coat rod on wardrobe side  
 Closed section with 1 adjustable shelf  
 2 box drawers and 1 file drawer with lock

### Specifications

Tops are  $\frac{3}{4}$ " H, square edge.  
 Adjustable shelves can be positioned each  $1\frac{1}{4}$ "  
 Levelers adjust up  $1\frac{9}{16}$ "  
 Box drawers with  $\frac{3}{4}$ " extension glides  
 File drawers with full extension glides  
 Hanging file bars included

### Finishes

Please specify top finish and body color.

EXAMPLE

S7151 3072 Z214 S301

# S7155

Split storage / wardrobe cabinet / file, file  
58" H

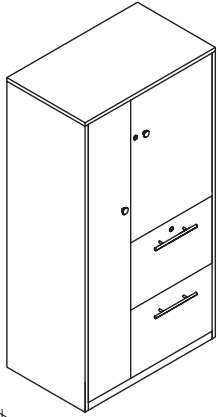

24"  
610 mm

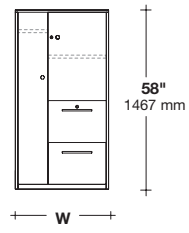

CODE	TOP / DOORS		DRAWER FRONTS	BODY / SHELVES	STEEL	VENEER	PVC	
	W	H						
S7155	30	58	STEEL		\$	\$	\$	
			S301	S301	2,223	2,433	2,907	
			S302	S302				
			S303	S303				
			S304	S304				
			S305	S305				
			S306	S306				
			S307	S307				
			S308	S308				
			VEENER					
			Z203					
			Z204					
			Z205					
			Z213					
			Z214					
			Z220					
			PVC					
			M101					
M103								
M104								
M105								
M106								
B102								

EXAMPLE

S7155 3058 Z214 S301

**Description**

2 hinged doors with lock  
Coat rod on wardrobe side  
Closed section with 1 adjustable shelf  
2 file drawers with lock

**Specifications**

Tops are 3/4" H, square edge  
Adjustable shelves can be positioned each 1 1/4"  
Levelers adjust up 1 9/16"  
File drawers with full extension glides  
Hanging file bars included

**Finishes**

Please specify top finish and body color.

# S7156

Split storage / wardrobe cabinet / box, box, file  
58" H

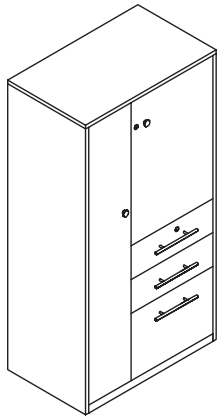

24"  
610 mm

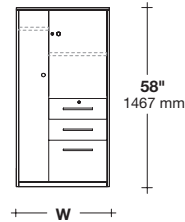

CODE	TOP / DOORS		DRAWER FRONTS	BODY / SHELVES	STEEL	VENEER	PVC
	W	H					
S7156	30	58	STEEL		\$	\$	\$
			S301	S301	2,280	2,493	2,993
			S302	S302			
			S303	S303			
			S304	S304			
			S305	S305			
			S306	S306			
			S307	S307			
			S308	S308			
			VENEER				
			Z203				
			Z204				
			Z205				
			Z213				
			Z214				
			Z220				
			PVC				
			M101				
M103							
M104							
M105							
M106							
B102							

### Description

2 hinged doors with lock  
Coat rod on wardrobe side  
Closed section with 1 adjustable shelf  
2 box drawers and 1 file drawer with lock

### Specifications

Tops are 3/4" H, square edge  
Adjustable shelves can be positioned each 1 1/4"  
Levelers adjust up 1 9/16"  
Box drawers with 3/4 extension glides  
File drawers with full extension glides  
Hanging file bars included

### Finishes

Please specify top finish and body color.

EXAMPLE

S7156 3058 Z214 S301

# S7157

## Split storage / wardrobe cabinet / box, box, file

Left / 44" H

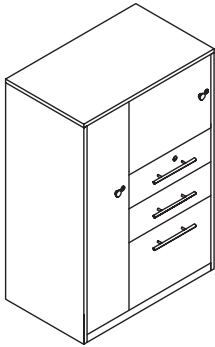

24"  
610 mm

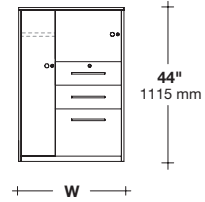

CODE	W	H	TOP / DOORS		STEEL	VENEER	PVC
			DRAWER FRONTS	BODY / SHELVES			
S7157	30	44	STEEL		\$	\$	\$
			S301	S301	1,927	2,123	2,560
			S302	S302			
			S303	S303			
			S304	S304			
			S305	S305			
			S306	S306			
			S307	S307			
			S308	S308			
			VENEER				
			Z203				
			Z204				
			Z205				
			Z213				
			Z214				
			Z220				
			PVC				
			M101				
M103							
M104							
M105							
M106							
B102							

### Description

2 hinged doors with lock  
Coat rod on wardrobe side  
2 box drawers and 1 file drawer with lock

### Specifications

Tops are 3/4" H, square edge  
Adjustable shelves can be positioned each 1 1/4"  
Levelers adjust up 1 9/16"  
Box drawers with 3/4 extension glides  
File drawers with full extension glides  
Hanging file bars included

### Finishes

Please specify top finish and body color.

EXAMPLE

S7157 3044 Z214 S301

# S7158

Split storage / wardrobe cabinet / box, box, file  
Right / 44" H

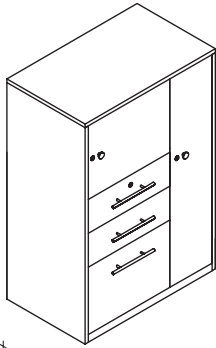

24"  
610 mm

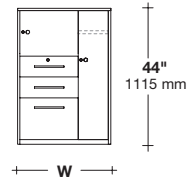

44"  
1115 mm

W

CODE	TOP / DOORS		DRAWER FRONTS	BODY / SHELVES	STEEL	VENEER	PVC
	W	H					
S7158	30	44	STEEL		\$	\$	\$
			S301	S301	1,927	2,123	2,560
			S302	S302			
			S303	S303			
			S304	S304			
			S305	S305			
			S306	S306			
			S307	S307			
			S308	S308			
			VENEER				
			Z203				
			Z204				
			Z205				
			Z213				
			Z214				
			Z220				
			PVC				
			M101				
M103							
M104							
M105							
M106							
B102							

### Description

2 hinged doors with lock  
Coat rod on wardrobe side  
2 box drawers and 1 file drawer with lock

### Specifications

Tops are  $\frac{3}{4}$ " H, square edge  
Adjustable shelves can be positioned each  $1\frac{1}{4}$ "  
Levelers adjust up  $1\frac{9}{16}$ "  
Box drawers with  $\frac{3}{4}$ " extension glides  
File drawers with full extension glides  
Hanging file bars included

### Finishes

Please specify top finish and body color.

EXAMPLE

S7158 3044 Z214 S301

# S7160

## Split storage / wardrobe cabinet / file 72" H

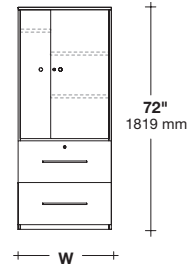
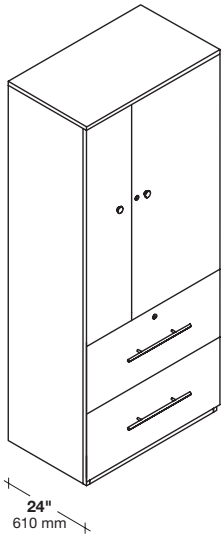

CODE	TOP / DOORS		DRAWER FRONTS	BODY / SHELVES	STEEL	VENEER	PVC	
	W	H						
<b>S7160</b>	<b>30</b>	<b>72</b>	<b>STEEL</b>		<b>\$</b>	<b>\$</b>	<b>\$</b>	
			<b>S301</b>	<b>S301</b>	<b>2,323</b>	<b>2,563</b>	<b>3,097</b>	
			<b>S302</b>	<b>S302</b>				
			<b>S303</b>	<b>S303</b>				
			<b>S304</b>	<b>S304</b>				
			<b>S305</b>	<b>S305</b>				
			<b>S306</b>	<b>S306</b>				
			<b>S307</b>	<b>S307</b>				
			<b>S308</b>	<b>S308</b>				
			<b>VEENER</b>					
			<b>Z203</b>					
			<b>Z204</b>					
			<b>Z205</b>					
			<b>Z213</b>					
			<b>Z214</b>					
			<b>Z220</b>					
			<b>PVC</b>					
			<b>M101</b>					
			<b>M103</b>					
			<b>M104</b>					
			<b>M105</b>					
			<b>M106</b>					
			<b>B102</b>					

### Description

2 hinged doors with lock  
Coat rod on wardrobe side  
Closed section with 2 adjustable shelves  
2 lateral file drawers with lock

### Specifications

Tops are 3/4" H, square edge.  
Adjustable shelves can be positioned each 1 1/4"  
Levelers adjust up 1 9/16"  
File drawers with full extension glides  
Hanging file bars included

### Finishes

Please specify top finish and body color.

EXAMPLE

**S7160 3072 Z214 S301**

# General Information and Selling Policies

## Order acceptance

All orders are required in writing and are subject to acceptance by RIVIERA. No salesperson, agent or representative is authorized to change these selling policies or terms and conditions of sale. Only the specifications, terms and conditions contained in accepted orders shall be binding upon the parties, regardless of buyer's order form listing variances as to specifications, terms, or conditions.

## Delivery time

Production orders take approximately 6 weeks to ship, after receipt acknowledgment of order, and approval of credit. Actual ship date may vary 2-4 working days for freight consolidation.

Without any unexpected delays in transportation, products should be delivered in 8 weeks.

RIVIERA is not liable for delay or failure to ship by the acknowledged date, either for transportation performance, or any cause which is not in RIVIERA's control.

## Quotations

Unless specified otherwise, all quotations are valid for sixty (60) days from date of issuance.

## Acknowledgments

RIVIERA sends acknowledgments on all orders. Be sure to read these acknowledgments and contact us immediately if incorrect.

Our acknowledgment of accepted order takes precedence over buyer's purchase order. Any error or discrepancy on acknowledgment must be reported to RIVIERA in writing within three (3) working days of acknowledgment date.

Changes to order at customer's request may result in additional charges based on costs incurred by RIVIERA. Once production has started, changes will not be accepted.

## Phone orders

RIVIERA cannot be responsible for errors made on phone orders if written confirmation has not been received. Duplicate orders not marked "Confirmation" are the responsibility of the customer.

## Cancellations

Orders cannot be canceled without the written consent of RIVIERA. Charges may be applicable based on costs incurred by RIVIERA. Special or custom orders are not subject to cancellation.

## Shipping

All merchandise whether shipping collect, prepaid/charge or delivered pricing is shipped F.O.B. origin, which means that ownership and the responsibility of the merchandise becomes that of the buyer upon delivery to the freight company.

All orders not qualifying for RIVIERA's delivered pricing will be shipped freight collect unless specified to be prepaid. On advance payment orders add 15% of total order for shipping. Remaining balance will be credited or invoiced to your account.

RIVIERA determines the method of transportation and the routing of shipment. RIVIERA may make partial shipment and invoice as shipped.

## Delivery charges

Any charges arising from failure to meet a shipment, rerouting while in transit, or carrier storage charges are not included in prices shown.

## Damaged merchandise

RIVIERA furniture is carefully inspected, protected with well-engineered packaging, and expertly loaded onto the trucks at our distribution center. All shipments leave the factory in good condition.

However, if merchandise is damaged in transit, do not refuse shipment, as RIVIERA is not responsible for damage to goods which occur in transit or storage.

RIVIERA is not responsible for the condition of product that is stored or installed in an environment where temperature and humidity are not controlled.

## Freight claims

RIVIERA shall not be liable for loss or damage to merchandise which occurs in transit. It is the customer's responsibility to examine shipment upon receipt. Any damage or shortage should be noted on the bill of lading. The delivering carrier may not accept responsibility for shortages or damages if signed for "clear". Notification of concealed damage claims must be made in writing to the delivering carrier within five (5) days after delivery. Carrier liability ceases after 5 days and carrier will not be responsible for concealed damages if shipments are left unopened.

If other than standard common carrier is used at customer's request, customer shall be responsible for any and all damages arising therein.

The manufacturer does not assemble nor install its furniture and is not responsible nor liable for such assembly and/or installation.

If you receive a product that is freight damaged, the following steps must be taken:

- 1) Before signing for the merchandise, make careful notation of all damages on the freight bill (bill of lading).
  - 2) Immediately file a claim with the delivering carrier. Request an inspection by the carrier agent.
  - 3) The claim must be filed within five (5) days of receipt of goods.
  - 4) Retain all shipping cartons for inspection by the carrier agent.
- For concealed damage, follow steps 2) through 4).

## Returns

No merchandise may be returned without RIVIERA's prior written consent. In the event of an authorized return, a restocking charge of 30% plus duty and brokerage, if applicable, will apply. Return transportation charges must be prepaid. Unauthorized returns will not be accepted and will be returned freight collect.

All merchandise being returned must be properly packaged in its original packaging or comparable replacement packaging to ensure protection of the product during handling and transportation. Product being returned where RIVIERA has authorized its liability for replacement or repair will be thoroughly inspected on its return. Any discrepancies, such as additional damage, signs of usage, missing parts, etc., will result in an adjustment to the amount of credit issued.

Special or custom orders are not subject to return.

## Storage

If customer requests postponement of delivery for any reason when RIVIERA is ready to make shipment, RIVIERA reserves the right to transfer the merchandise to storage at customer's risk and expense. Such transfer to storage will be deemed delivery to customer for all purposes including invoicing and payment.

## Terms of sale

2% - 10 days, net 30 days. RIVIERA may cancel or change the terms of sale at any time based on the credit rating for the specific customer. Payment in advance may be requested at discretion of RIVIERA.

Terms are net and cash discounts are not applicable.

Federal, state, provincial, municipal, sales or other taxes are not included.

## Prices

List prices include delivery to one destination, unless otherwise specified and are subject to change without notice. Installation and/or storage costs are not included in prices, unless otherwise specified.

Prices listed are suggested retail.

## Deposits

Any special or custom order, or order with modification to our standard product will require a 50% deposit. Any order exceeding customer line of credit will require a deposit for the difference.

## Changes to product

RIVIERA reserves the right to make changes in materials, equipment, specifications and designs and to discontinue models without notice at any time.

### **Weights and dimensions**

All weights and dimensions listed are approximate.

### **Fire and Building Codes**

RIVIERA considers its series as portable furniture, subject to local fire and building codes. Installation and use of the furniture in accordance with all local, applicable codes is the responsibility of the customer.

## **Care and Maintenance**

Care must be exercised whenever cleaning materials constructed of wood or leather. Certain precautions will keep new furniture looking new.

Wet objects should be placed on coasters and writing should be done on a desk pad. Sharp metal objects such as spring binders and briefcase hinges should be kept from contact.

Contact between finish and certain plastic compounds may result in discoloration and finish damage. Avoid exposure of furniture to extremes of heat or cold.

Avoid exposing the furniture to strong sunlight. Although RIVIERA finish is as fade proof as possible, the veneer beneath the finish can change color due to sunlight.

### **Wood finishes**

Dust all surfaces frequently with a clean, soft, damp cloth, moving the cloth with the grain. General purpose dusting treatments should be applied as required by using a clean dry cloth.

Do not use spray polishes or those containing silicone. Spray polishing products such as "Pledge" or "Endust" are discouraged on RIVIERA furniture because use of these products may result in an oily build up.

### **Maintenance**

To maintain proper operation of the drawer suspension, lubricate the area housing the ball bearings every three to six months with a high quality petroleum jelly type lubricant.

To ensure correct drawer alignment, your desk or credenza must be leveled. Check to see that unit is level and adjust the glides if necessary.

## **RIVIERA WARRANTY**

RIVIERA warrants its products to be free from defects in material and workmanship for as long as the original purchaser owns them.

RIVIERA will repair or replace with comparable product, free of charge, any RIVIERA product or component manufactured after January 1, 2000 that fails under normal commercial office use.

Product repair or replacement is the customer's exclusive remedy for any and all product defects.

RIVIERA shall in no way and under no circumstances be liable for any incidental, economic, consequential, or exemplary damages.

This warranty is subject to the following provisions:

Some natural variations occurring in wood or other natural materials are inherent to their character and not considered defects. RIVIERA does not warrant the colorfastness or matching of colors, grains or textures of these materials.

Additionally, a Customer's Own Material (C.O.M.) selected by and used at the request of a user, is not warranted.

This warranty does not apply to:

- Normal wear and tear over the course of ownership.
- Modifications or attachments to the product not approved by RIVIERA.
- Products not installed, used or maintained in accordance with product instructions and warnings.
- Products used for rental purposes.
- Damage caused by the carrier in-transit, which is handled under separate terms.

To the extent allowed by law, RIVIERA makes no other warranty, either express or implied, including any warranty of merchantability or fitness for a particular purpose.

This warranty applies only to products sold within the United States of America and Canada. Your RIVIERA dealer is our partner in supporting your warranty requests. To obtain service under this warranty, please contact your RIVIERA dealer.



# Numerical Index

CODE .....PAGE

S7131.....	8
S7132.....	9
S7133.....	10
S7135.....	11
S7136.....	12
S7137.....	13
S7143.....	14
S7144.....	15
S7147.....	16
S7150.....	17
S7151.....	18
S7155.....	19
S7156.....	20
S7157.....	21
S7158.....	22
S7160.....	23



#### Corporate offices & showrooms

Mexico City  
Paseo de las Palmas, 800  
Col. Lomas de Chapultepec  
11000

Phone: 525 5 11 00 2200  
Fax: 525 5 52 02 6288

New York  
641 Lexington Avenue  
22nd floor  
New York, NY 10022

Phone: 212 832 4260  
Fax: 212 832 4274

Chicago  
Merchandise Mart,  
Suite 341,  
Chicago, Illinois 60654

Phone: 312 329 0582  
Fax: 312 329 0622

[www.riviera-usa.com](http://www.riviera-usa.com)