



GRASSOLER COLLECTION

PRICE LIST
OCTOBER 2013

Grassoler, headquartered in Barcelona has been designing and manufacturing the highest quality lounge furnishings for over fifty years.

Innovations, design, quality and comfort are core tenets of the company.

Project installations are on all five continents, provided by a global network of over 100 sales and service organizations. Grassoler is proud to have established a licensed manufacturing and distribution partnership with RIVIERA to serve all The Americas.

Terms and Conditions

Manufacturing time: 6 weeks from receipt of purchase order with all sizes and finishes.

Add an extra 2 weeks for COM fabric

50% deposit is required on all orders.

Quote is valid for 30 days

Prices are List prices in US\$

Prices are subject to change without notice.

Prices are ex-factory. Freight is NOT included.

Guarantee

Metal frame: 10 years

Wood Frame: 5 years

Fabric: 3 years normal wear/usage

Guarantee only covers manufacturing defects and normal usage

Code

MG	BR2010	S1	CB	2726	T00	TWA101	S1	S402																																													
Grassoler Collection	Product Code	Seater	Arms	Dimensions	Fabric / Leather Grade	Fabric Code	Feet Finish	Finish Code																																													
<table border="1"> <tr><td>S1</td><td>One</td></tr> <tr><td>S2</td><td>Two</td></tr> <tr><td>S25</td><td>Two and a half</td></tr> <tr><td>S3</td><td>Three</td></tr> <tr><td>S35</td><td>Three and a half</td></tr> <tr><td>S4</td><td>Four</td></tr> <tr><td>S45</td><td>Four and a half</td></tr> <tr><td>S5</td><td>Five</td></tr> </table>	S1	One	S2	Two	S25	Two and a half	S3	Three	S35	Three and a half	S4	Four	S45	Four and a half	S5	Five		<table border="1"> <tr><td>CB</td><td>With arms</td></tr> <tr><td>SB</td><td>No arms</td></tr> <tr><td>BD</td><td>Right arm</td></tr> <tr><td>BI</td><td>Left arm</td></tr> </table>	CB	With arms	SB	No arms	BD	Right arm	BI	Left arm			<table border="1"> <tr><td>T00</td></tr> <tr><td>T05</td></tr> <tr><td>T06</td></tr> <tr><td>T07</td></tr> <tr><td>T08</td></tr> <tr><td>T09</td></tr> <tr><td>T10</td></tr> <tr><td>T11</td></tr> <tr><td>T31</td></tr> <tr><td>T32</td></tr> <tr><td>T33</td></tr> <tr><td>T34</td></tr> <tr><td>T35</td></tr> </table>	T00	T05	T06	T07	T08	T09	T10	T11	T31	T32	T33	T34	T35		<table border="1"> <tr><td>S1</td><td>Metal painted</td></tr> <tr><td>S2</td><td>Chromed</td></tr> <tr><td>Z1</td><td>Veneer</td></tr> <tr><td>C1</td><td>Black plastic</td></tr> </table>	S1	Metal painted	S2	Chromed	Z1	Veneer	C1	Black plastic	
S1	One																																																				
S2	Two																																																				
S25	Two and a half																																																				
S3	Three																																																				
S35	Three and a half																																																				
S4	Four																																																				
S45	Four and a half																																																				
S5	Five																																																				
CB	With arms																																																				
SB	No arms																																																				
BD	Right arm																																																				
BI	Left arm																																																				
T00																																																					
T05																																																					
T06																																																					
T07																																																					
T08																																																					
T09																																																					
T10																																																					
T11																																																					
T31																																																					
T32																																																					
T33																																																					
T34																																																					
T35																																																					
S1	Metal painted																																																				
S2	Chromed																																																				
Z1	Veneer																																																				
C1	Black plastic																																																				

ARTEMIS - ARMCHAIR

One seater

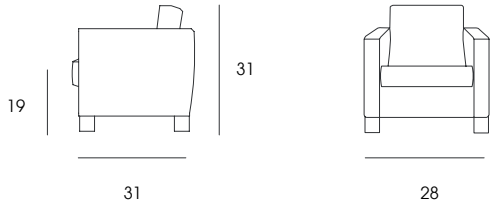

Specifications:

Frame:

Mdf frame, with polyether foam cushion (cfc free)

Suspension:

Interlaced elastic webbing

Feet:

Chromed metallic feet

Cover:

Fixed upholstered

Seat:

77 lb. polyether foam

Back:

66 lb. polyether foam

CODE	SEATER	ARMS	D	W	FABRIC	METAL	\$
MGAR2010	S1	CB	31	28	T00	S2	1,730
					T05		2,082
					T06		2,166
					T07		2,276
					T08		2,446
					T09		2,619
					T10		2,876
					T11		3,136
					T12		3,523
					T31		
					T32		
					T33		
					T34		
					T35		

EXAMPLE

MGAR2010 S1 CB 3128 T00 - TWA101 - S2 - SR340

ARTEMIS - LOVESEAT

Two seater

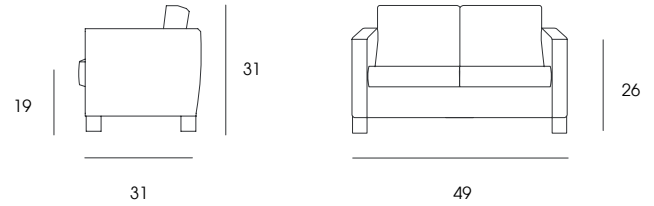

Specifications:

Frame:

Mdf frame, with polyether foam cushion (cfc free)

Suspension:

Interlaced elastic webbing

Feet:

Chromed metallic feet

Cover:

Fixed upholstered

Seat:

77 lb. polyether foam

Back:

65 lb. polyether foam

CODE	SEATER	ARMS	D	W	FABRIC	METAL	\$
MGAR2020	S2	CB	31	49	T00	S2	1,964
					T05		2,579
					T06		2,729
					T07		2,917
					T08		3,220
					T09		3,520
					T10		3,974
					T11		4,427
					T12		5,106
					T31		
					T32		
					T33		
					T34		
					T35		

EXAMPLE

MGAR2020 S2 CB 3149 T00 - TWA101 - S2 - SR340

BERLIN - ARMCHAIR

One seater

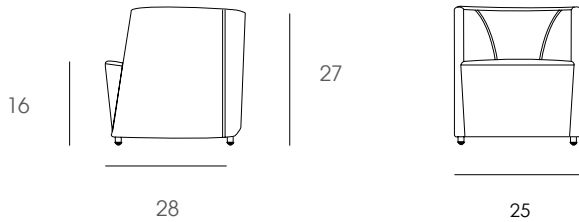

Specifications:

Frame:

Mdf frame, with polyether foam cushion (cfc free)

Feet:

Metallic feet

Cover:

Fixed upholstered

Seat:

77 lb. polyether foam

Back:

77 lb. polyether (cfc. free)

CODE	SEATER	ARMS	D	W	FABRIC	METAL	\$
MGBE2010	S1	CB	28	25	T00	S1	875
					T05		1,175
					T06		1,248
					T07		1,340
					T08		1,490
					T09		1,637
					T10		1,857
					T11		2,079
					T12		2,411
					T31		
					T32		
					T33		
					T34		
					T35		

EXAMPLE

MGBE2010 S1 CB 2825 T00 - TWA101 - S1 - S402

BERNA - ARMCHAIR

One seater

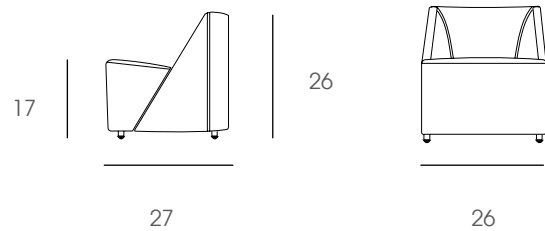

Specifications:

Frame:

Mdf frame, with polyether foam cushion (cfc. free)

Feet:

Metallic Feet

Cover:

Fixed upholstered

Seat:

77 lb. polyether foam

Back:

77 lb. polyether foam

CODE	SEATER	ARMS	D	W	FABRIC	METAL	\$
MGBR2010	S1	CB	27	26	T00	S1	751
					T05		973
					T06		1,031
					T07		1,097
					T08		1,210
					T09		1,320
					T10		1,484
					T11		1,649
					T12		1,897
					T31		
					T32		
					T33		
					T34		
					T35		

EXAMPLE

MGBR2010 S1 CB 2726 T00 - TWA101 - S1 - S402

ELDER - ARMCHAIR - METAL PAINTED

One seater

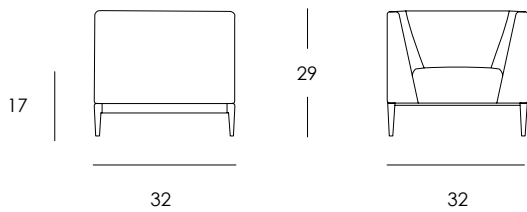

Specifications:

Frame:

Mdf, covered by polyether. Removable structure.

Suspension:

Interlaced elastic webbing.

Cover:

Fixed upholstered

Seat:

77 lb. polyether (cfc. free).

Back:

77 lb. polyether (cfc. free).

Feet:

Metallic feet painted with an antisliding rubber cap.
Removable feet.

Base:

Same color as feet.

NOTE:

*Bases are included.

CODE	SEATER	ARMS	D	W	FABRIC	METAL	\$
MGER2010	S1	CB	32	32	T00	S1	2,391
					T05		2,778
					T06		2,873
					T07		2,992
					T08		3,182
					T09		3,370
					T10		3,656
					T11		3,942
					T12		4,369
					T31		
					T32		
					T33		
					T34		
					T35		

EXAMPLE

MGER2010 S1 CB 3232 T00 - TWA101 - S1- S402

ELDER - ARMCHAIR - CHROMED METALLIC

One seater

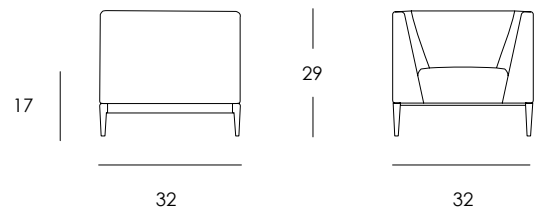

Specifications:

Frame:

Mdf, covered by polyether.
Removable structure.

Suspension:

Interlaced elastic webbing.

Cover:

Fixed upholstered

Seat:

77 lb. polyether (cfc. free).

Back:

77 lb. polyether (cfc. free).

Feet:

Polished ALUMINUM with an antisliding rubber cap.
Removable feet.

Base:

Metallic chromed.

NOTE:

*Bases are included.

CODE	SEATER	ARMS	D	W	FABRIC	METAL	\$
MGER2110	S1	CB	32	32	T00	S2	3,139
					T05		3,526
					T06		3,621
					T07		3,740
					T08		3,930
					T09		4,118
					T10		4,404
					T11		4,690
					T12		5,117
					T31		
					T32		
					T33		
					T34		
					T35		

EXAMPLE

MGER2110 S1 CB 3232 T00 - TWA101 - S2 - SR340

ELDER - SOFA BASE

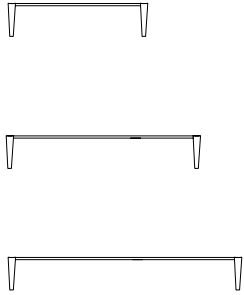

Specifications:

Base:

Laminated steel.

Feet:

Metallic feet painted or polished aluminum, with an antisliding rubber cap. Removable feet.

Option:

with aluminum feet the base is chromed.

CODE	D	W	METAL	S1	S2
MGER3010	32	32	S1	725	970
		63	S2	791	1,187
		96		889	1,415

EXAMPLE

MGER3010 3232 - S2 - SR340

ELDER - SOFA TOP - NO BASE

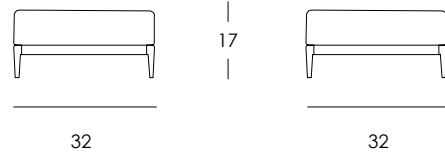

Specifications:

Frame:

Mdf, covered by polyether.

Suspension:

Interlaced elastic webbing.

Cover:

Fixed upholstered

Seat:

77 lb. polyether (cfc. free).

NOTE:

*Bases are ordered separately.

CODE	D	W	FABRIC	\$
MGER2061	32	32	T00	696
			T05	858
			T06	895
			T07	944
			T08	1,022
			T09	1,100
			T10	1,219
			T11	1,337
			T12	1,513
			T31	
			T32	
			T33	
T34				
T35				

EXAMPLE

MGER2061 3232 T00 - TWA101

ELDER - ARMCHAIR - RIGHT ARM - NO BASE

One seater

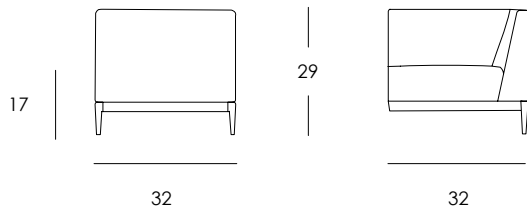

Specifications:

Frame:

Mdf, covered by polyether.

Suspension:

Interlaced elastic webbing.

Cover:

Fixed upholstered

Seat:

77 lb. polyether (cfc. free).

Back:

77 lb. polyether (cfc. free).

NOTE:

*Bases are ordered separately.

CODE	SEATER	ARMS	D	W	FABRIC	\$
MGER2011	S1	BD	32	32	T00	1,357
					T05	1,669
					T06	1,747
					T07	1,842
					T08	1,996
					T09	2,151
					T10	2,382
					T11	2,614
					T12	2,960
					T31	
					T32	
					T33	
					T34	
					T35	

EXAMPLE

MGER2011 S1 BD 3232 T00 - TWA101

ELDER - ARMCHAIR - LEFT ARM - NO BASE

One seater

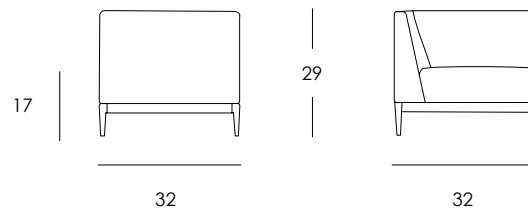

Specifications:

Frame:

Mdf, covered by polyether.

Suspension:

Interlaced elastic webbing.

Cover:

Fixed upholstered

Seat:

77 lb. polyether (cfc. free).

Back:

77 lb. polyether (cfc. free).

NOTE:

*Bases are ordered separately.

CODE	SEATER	ARMS	D	W	FABRIC	\$
MGER2012	S1	BI	32	32	T00	1,357
					T05	1,669
					T06	1,747
					T07	1,842
					T08	1,996
					T09	2,151
					T10	2,382
					T11	2,614
					T12	2,960
					T31	
					T32	
					T33	
					T34	
					T35	

EXAMPLE

MGAR2012 S1 BI 3232 T00 - TWA101

ELDER - ARMLESSCHAIR - NO BASE

One seater

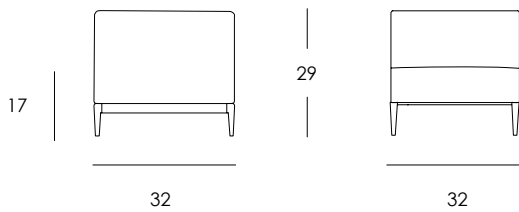

Specifications:

Frame:

Mdf, covered by polyether.

Suspension:

Interlaced elastic webbing.

Cover:

Fixed upholstered

Seat:

77 lb. polyether (cfc. free).

Back:

77 lb. polyether (cfc. free).

NOTE:

*Bases are ordered separately.

CODE	SEATER	ARMS	D	W	FABRIC	\$
MGER2013	S1	SB	32	32	T00	1,259
					T05	1,507
					T06	1,565
					T07	1,643
					T08	1,762
					T09	1,883
					T10	2,065
					T11	2,247
					T12	2,518
					T31	
					T32	
					T33	
					T34	
					T35	

EXAMPLE

MGER2013 S1 SB 3232 T00 - TWA101

ELDER - CORNER UNIT - NO BASE

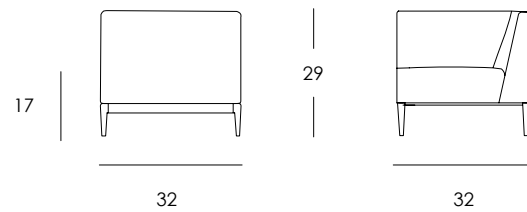

Specifications:

Frame:

Mdf, covered by polyether.

Suspension:

Interlaced elastic webbing.

Cover:

Fixed upholstered

Seat:

77 lb. polyether (cfc. free).

Back:

77 lb. polyether (cfc. free).

NOTE:

*Bases are ordered separately.

CODE	D	W	FABRIC	\$
MGER2050	32	32	T00	1,308
			T05	1,663
			T06	1,753
			T07	1,860
			T08	2,036
			T09	2,212
			T10	2,475
			T11	2,738
			T12	3,130
			T31	
			T32	
			T33	
			T34	
			T35	

EXAMPLE

MGER2050 3232 T00 - TWA101

EUPHORIA - ARMCHAIR - METAL PAINTED

One seater

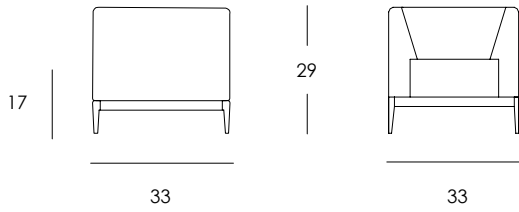

Specifications:

Frame:

Metallic anticorrosion painted, with Mdf on the back, covered by polyether.

Base:

Same color as feet. Removable structure.

Arms:

Mdf frame covered by polyether.

Suspension:

"Nosag" metallic spring

Feet:

Metallic feet painted. Removable feet.

Cover:

Fixed upholstered.

Seat:

77 lb. polyether (cfc. free).

Back:

66 / 88 lb. polyether(cfc. free).

CODE	SEATER	ARMS	D	W	FABRIC	METAL	\$
MGEP2010	S1	CB	33	33	T00	S1	1,854
					T05		2,371
					T06		2,498
					T07		2,657
					T08		2,908
					T09		3,162
					T10		3,543
					T11		3,925
					T12		4,494
					T31		
					T32		
					T33		
					T34		
					T35		

EXAMPLE

MGEP2010 S1 CB 3333 - T00 - TWA101 - S1 - S402

EUPHORIA - ARMCHAIR - POLISHED ALUMINUM

One seater

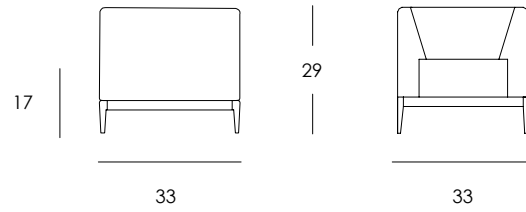

Specifications:

Frame:

Metallic anticorrosion painted, with Mdf on the back, covered by polyether.

Base:

Metallic chromed. Removable structure.

Arms:

Mdf frame covered by polyether.

Suspension:

"Nosag" metallic spring

Feet:

Polished aluminum. Removable feet.

Cover:

Fixed upholstered.

Seat:

77 lb. polyether (cfc. free).

Back:

66 / 88 lb. polyether(cfc. free).

CODE	SEATER	ARMS	D	W	FABRIC	METAL	\$
MGEP2110	S1	CB	33	33	T00	S2	2,481
					T05		3,096
					T06		3,125
					T07		3,281
					T08		3,535
					T09		3,789
					T10		4,170
					T11		4,551
					T12		5,120
					T31		
					T32		
					T33		
					T34		
					T35		

EXAMPLE

MGEP2110 S1 CB 3333 - T00 - TWA101 - S2 - SR340

EUPHORIA - SOFA BASE

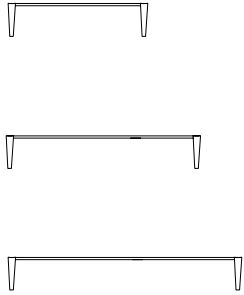

Specifications:

Base:

Laminated steel.
Removable structure.

Option:

Metalized or chrome finish.

CODE	D	W	METAL	S1	S2
MGEP3010	33	33	S1	797	1,178
		49	S2	837	1,239
		66		861	1,352
		73		895	1,424
		91		1,022	1,828
		100		1,086	1,935

EXAMPLE

MGEP3010 3333 - S2 - SR340

EUPHORIA - ARMLESS CHAIR - NO BASE

One seater

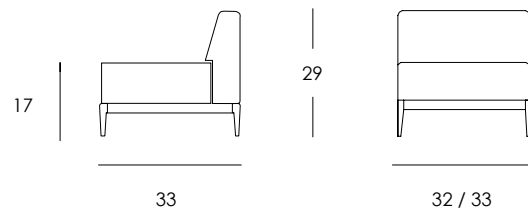

Specifications:

Frame:

Metallic anticorrosion painted, with Mdf on the back, covered by polyether.

Suspension:

"Nosag" metallic spring

Seat:

77 lb. polyether (cfc. free).

Back:

66 / 88 lb. polyether(cfc. free).

Option:

Metallic arm. (can be placed on any side)

NOTE:

*Bases and arms are ordered separately.

CODE	SEATER	ARMS	D	W	FABRIC	\$	
MGEP2013	S1	SB	33	25	T00	644	
					T05	959	
					T06	1,034	
					T07	1,132	
					T08	1,285	
					T09	1,438	
					T10	1,669	
					T11	1,900	
					T12	2,247	
					33	T31	967
						T32	1,323
						T33	1,409
		T34	1,519				
		T35	1,695				
			1,868				
		2,131					
		2,394					
		2,790					

EXAMPLE

MGEP2013 S1 SB 3333 - T00 - TWA101

EUPHORIA - CORNER UNIT - NO BASE

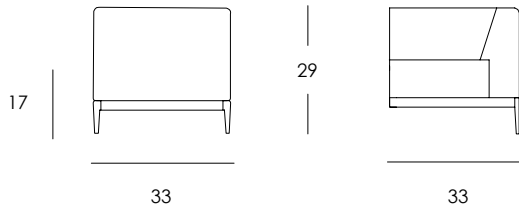

Specifications:

Frame:

Metallic anticorrosion painted, with Mdf on the back, covered by polyether.

Suspension:

"Nosag" metallic spring

Seat:

77 lb. polyether (cfc. free).

Back:

66 / 88 lb. polyether(cfc. free).

NOTE:

*Bases are ordered separately.

CODE	D	W	FABRIC	\$
MGEP2050	33	33	T00	2,221
			T05	2,709
			T06	2,830
			T07	2,980
			T08	3,220
			T09	3,460
			T10	3,821
			T11	4,182
			T12	4,725
			T31	
			T32	
			T33	
			T34	
			T35	

EXAMPLE

MGEP2050 3333 - T00 - TWA101

EUPHORIA - LOW TABLE - NO BASE



Specifications:

Veneer table.

Refer to color chart.

NOTE:

*Bases are ordered separately.

CODE	D	W	WOOD	\$
MGEP8030	33	24	Z1	349
		33		407

EXAMPLE

MGEP8030 3333 - Z1 - Z501

EUPHORIA - COFFEE TABLE - METAL PAINTED

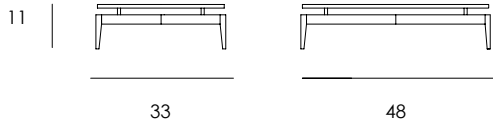

Specifications:

Veneer table.
Refer to color chart.

NOTE:

*Bases are included

CODE	D	W	WOOD	METAL	\$
MGEP8031	33	48	Z1	S1	1,146

EXAMPLE

MGEP8031 3348 - Z1 - Z501 - S1 - S402

EUPHORIA - COFFEE TABLE - POLISHED ALUMINUM

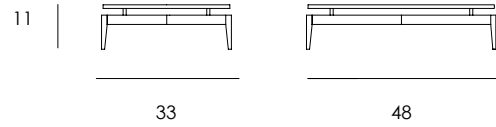

Specifications:

Veneer table.
Refer to color chart.

NOTE:

*Bases are included

CODE	D	W	WOOD	METAL	\$
MGEP8131	33	48	Z1	S2	1,421

EXAMPLE

MGEP8131 3348 - Z1 - Z501 - S2 - SR340

EUPHORIA - METALLIC RIGHT ARM

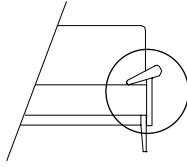

Specifications:

Metallic painted covered by polyether.

NOTE:

*Arms can be placed on any side except when using the corner as an arm function.

CODE	ARMS	FABRIC	METAL	\$
MGEP2090	BD	T00	S1	136
		T05		222
		T06		243
		T07		271
		T08		312
		T09		355
		T10		419
		T11		482
		T12		578
		T31		
		T32		
		T33		
		T34		
		T35		

EXAMPLE

MGEP2090 BD - T00 - TWA101 - S1 - S402

EUPHORIA - METALLIC LEFT ARM

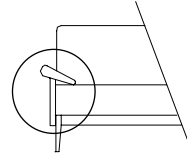

Specifications:

Metallic painted covered by polyether.

NOTE:

*Arms can be placed on any side except when using the corner as an arm function.

CODE	ARMS	FABRIC	METAL	\$
MGEP2091	BI	T00	S1	136
		T05		222
		T06		243
		T07		271
		T08		312
		T09		355
		T10		419
		T11		482
		T12		578
		T31		
		T32		
		T33		
		T34		
		T35		

EXAMPLE

MGEP2091 BI - T00 - TWA101 - S1 - S402

EUPHORIA - RIGHT ARM - POLISHED ALUMINUM

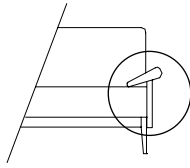

Specifications:

Metal covered by polyether.
Polished aluminum finish.

NOTE:

*Arms can be placed on any side except when using the corner as an arm function.

CODE	ARMS	FABRIC	METAL	\$
MGEP2190	BD	T00	S2	231
		T05		341
		T06		370
		T07		404
		T08		456
		T09		511
		T10		592
		T11		676
		T12		797
		T31		
		T32		
		T33		
		T34		
		T35		

EXAMPLE

MGEP2190 BD T00 - TWA101 - S2 - SR340

EUPHORIA - LEFT ARM - POLISHED ALUMINUM

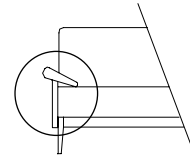

Specifications:

Metal covered by polyether.
Polished aluminum finish.

NOTE:

*Arms can be placed on any side except when using the corner as an arm function.

CODE	ARMS	FABRIC	METAL	\$
MGEP2191	BI	T00	S2	231
		T05		341
		T06		370
		T07		404
		T08		456
		T09		511
		T10		592
		T11		676
		T12		797
		T31		
		T32		
		T33		
		T34		
		T35		

EXAMPLE

MGEP2191 BD T00 - TWA101 - S2 - SR340

EUPHORIA - SOFA TOP - NO BASE

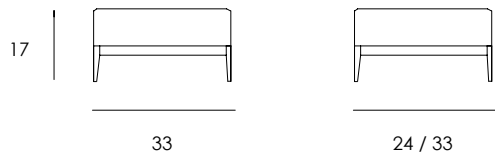

Specifications:

Frame:

Metallic anticorrosion painted, with Mdf on the back, covered by polyether.

Suspension:

"Nosag" metallic spring

Cover:

Fixed upholstered.

Seat:

77 lb. polyether (cfc. free).

NOTE:

*Bases are ordered separately.

CODE	D	W	FABRIC	\$		
MGEP2061	33	24	T00	445		
			T05	653		
			T06	705		
			T07	768		
			T08	872		
			T09	973		
			T10	1,129		
			T11	1,282		
			T12	1,513		
			33	33	T31	731
					T32	941
					T33	993
			T34	1,060		
			T35	1,164		
				1,268		
			1,424			
			1,583			
			1,816			

EXAMPLE

MGEP2061 3333 - T00 - TWA101

EVERY - ARMCHAIR - METAL PAINTED

One seater

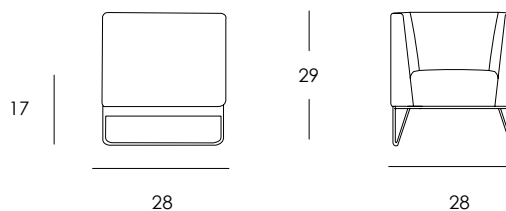

Specifications:

Frame and base:

Metallic anticorrosion painted, with Mdf, covered by polyether.

Suspension:

Interlaced elastic webbing

Feet:

Metal painted.

Cover:

Fixed upholstered

Seat:

66 / 88 polyether (cfc. free).

Back:

77 lb. polyether (cfc. free).

NOTE:

*Base is included

CODE	SEATER	ARMS	D	W	FABRIC	METAL	\$					
MGEV2010	S1	CB	28	28	T00	S1	1,334					
					T05		1,669					
					T06		1,753					
					T07		1,857					
					T08		2,022					
					T09		2,186					
					T10		2,434					
					T11		2,683					
					T12		3,052					
										T31		
										T32		
										T33		
						T34						
						T35						

EXAMPLE

MGEV2010 S1 CB 2828 T00 - TWA101 - S1 - S402

EVERY - ARMCHAIR - POLISHED ALLUMINUM

One seater

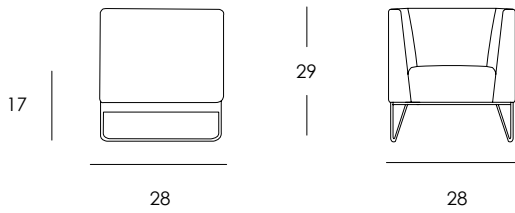

Specifications:

Frame and base:

Metallic anticorrosion painted, with Mdf, covered by polyether.

Suspension:

Interlaced elastic webbing

Feet:

Metal, polished aluminum

Cover:

Fixed upholstered

Seat:

66 / 88 polyether (cfc. free).

Back:

77 lb. polyether (cfc. free).

NOTE:

*Base is included

CODE	SEATER	ARMS	D	W	FABRIC	METAL	\$
MGEV2110	S1	CB	28	28	T00	S2	1,764
					T05		2,102
					T06		2,183
					T07		2,287
					T08		2,452
					T09		2,616
					T10		2,865
					T11		3,113
					T12		3,486
					T31		
					T32		
					T33		
					T34		
					T35		

EXAMPLE

MGEV2110 S1 CB 2828 T00 - TWA101 - S2 - SR340

EVERY - SOFA BASE

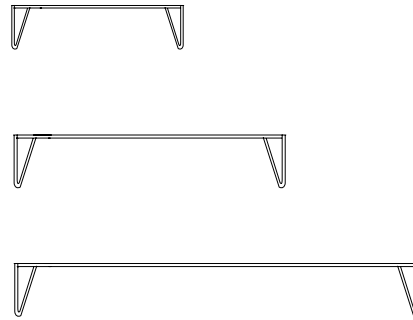

Specifications:

Base:

Metallic anticorrosion painted

Feet:

Metal, chromed or painted.

CODE	D	W	METAL	S1	S2
MGEV3010	28	28	S1	170	601
		55	S2	225	739
		83		283	1,155

EXAMPLE

MGEV3010 2828 - S1 - S402

EVERY - ARMCHAIR - RIGHT ARM - NO BASE

One seater

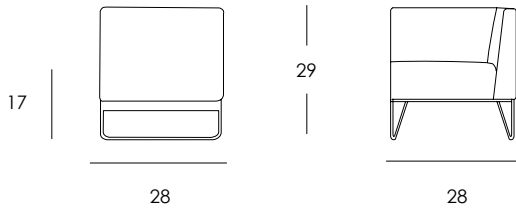

Specifications:

Frame:
Mdf, covered by polyether.

Suspension:
Interlaced elastic webbing

Cover:
Fixed upholstered

Seat:
66 / 88 polyether (cfc. free).

Back:
77 lb. polyether (cfc. free).

NOTE:
*Bases are ordered separately.

CODE	SEATER	ARMS	D	W	FABRIC	\$
MGEV2011	S1	BD	28	28	T00	1,149
					T05	1,415
					T06	1,481
					T07	1,562
					T08	1,692
					T09	1,822
					T10	2,019
					T11	2,215
					T12	2,507
					T31	
					T32	
					T33	
					T34	
					T35	

EXAMPLE
MGEV2110 S1 BD 2828 T00 - TWA101

EVERY - ARMCHAIR - LEFT ARM - NO BASE

One seater

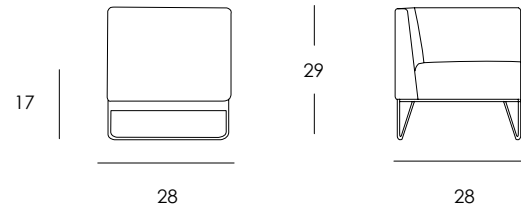

Specifications:

Frame:
Mdf, covered by polyether.

Suspension:
Interlaced elastic webbing

Cover:
Fixed upholstered

Seat:
66 / 88 polyether (cfc. free).

Back:
77 lb. polyether (cfc. free).

NOTE:
*Bases are ordered separately.

CODE	SEATER	ARMS	D	W	FABRIC	\$
MGEV2012	S1	BI	28	28	T00	1,149
					T05	1,415
					T06	1,481
					T07	1,562
					T08	1,692
					T09	1,822
					T10	2,019
					T11	2,215
					T12	2,507
					T31	
					T32	
					T33	
					T34	
					T35	

EXAMPLE
MGEV2012 S1 BI 2828 T00 - TWA101

EVERY - ARMLESS CHAIR - NO BASE

One seater

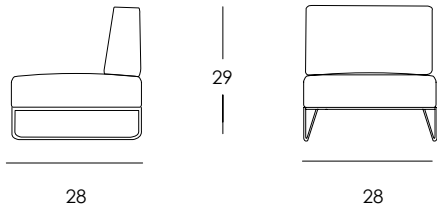

Specifications:

Frame:

Mdf, covered by polyether.

Suspension:

Interlaced elastic webbing

Cover:

Fixed upholstered

Seat:

66 / 88 polyether (cfc. free).

Back:

77 lb. polyether (cfc. free).

NOTE:

*Bases are ordered separately.

CODE	SEATER	ARMS	D	W	FABRIC	\$
MGEV2013	S1	SB	28	28	T00	892
					T05	1,100
					T06	1,152
					T07	1,216
					T08	1,320
					T09	1,421
					T10	1,577
					T11	1,730
					T12	1,961
					T31	
					T32	
					T33	
					T34	
					T35	

EXAMPLE

MGEV2013 S1 SB 2828 T00 - TWA101

EVERY - OTTOMAN - NO BASE



Specifications:

Frame:

Mdf, covered by polyether.

Suspension:

Interlaced elastic webbing

Cover:

Fixed upholstered

Seat:

66 / 88 polyether (cfc. free).

NOTE:

*Bases are ordered separately.

CODE	D	W	FABRIC	\$
MGEV2061	28	28	T00	653
			T05	823
			T06	866
			T07	918
			T08	1,002
			T09	1,089
			T10	1,216
			T11	1,340
			T12	1,531
			T31	
			T32	
			T33	
			T34	
			T35	

EXAMPLE

MGEV2061 2828 T00 - TWA101

FINCA MINI - ARMCHAIR

One seater

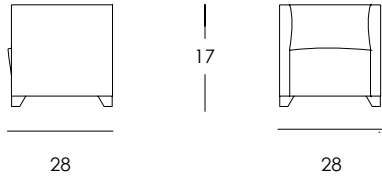

Specifications:

Frame:

Mdf frame, covered with polyether

Suspension:

Interlaced elastic webbing

Feet:

vener

Cover:

Fixed upholstered

Seat:

77 lb. polyether foam

Back:

66 lb. polyether foam

GLAMOUR - ARMCHAIR

One seater

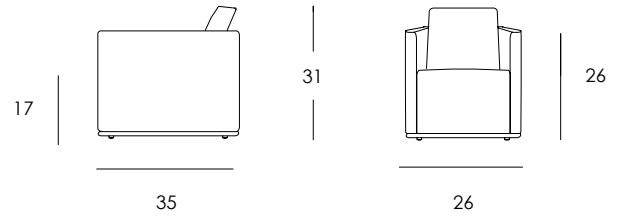

Specifications:

Frame:

Mdf frame covered with polyether

Suspension:

Interlaced elastic webbing

Feet:

Chromed base with 4 casters or 4 metallic feet.

Cover:

Fixed upholstered

Seat:

77 lb. polyether foam

Back:

65 lb. polyether foam

CODE	SEATER	ARMS	D	W	FABRIC	WEBCAD	\$
MGFM2010	S1	CB	28	27	T00	Z1	1,213
					T05		1,655
					T06		1,764
					T07		1,900
					T08		2,117
					T09		2,333
					T10		2,660
					T11		2,986
					T12		3,474
					T31		
					T32		
					T33		
					T34		
					T35		

EXAMPLE

MGFM2010 S1 CB 2827 T00 - TWA101 - Z1 - Z501

CODE	SEATER	ARMS	D	W	FABRIC	METAL	\$
MGGL2010	S1	CB	35	26	T00	S2	1,949
					T05		2,429
					T06		2,567
					T07		2,735
					T08		3,006
					T09		3,281
					T10		3,688
					T11		4,095
					T12		4,704
					T31		
					T32		
					T33		
					T34		
					T35		

EXAMPLE

MGGL2010 S1 CB 3526 T00 - TWA101 - S2 - SR340

GLAMOUR - SOFA - 54"

Two seater

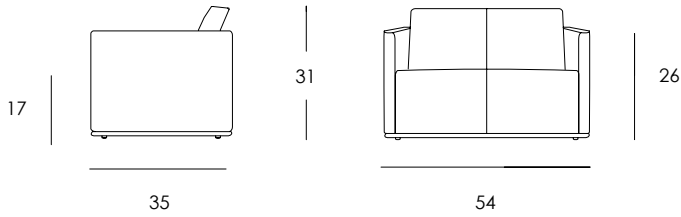

Specifications:

Frame:

Mdf frame covered with polyether

Suspension:

Interlaced elastic webbing

Feet:

Chromed base with 4 casters or 4 metallic feet.

Cover:

Fixed upholstered

Seat:

77 lb. polyether foam

Back:

65 lb. polyether foam

GLAMOUR - SOFA - 62"

Two and a half seater

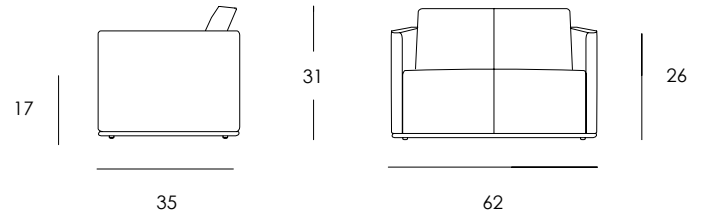

Specifications:

Frame:

Mdf frame covered with polyether

Suspension:

Interlaced elastic webbing

Feet:

Chromed base with 4 casters or 4 metallic feet.

Cover:

Fixed upholstered

Seat:

77 lb. polyether foam

Back:

65 lb. polyether foam

CODE	SEATER	ARMS	D	W	FABRIC	METAL	\$
MGGL2020	S2	CB	35	54	T00	S2	3,468
					T05		4,237
					T06		4,430
					T07		4,673
					T08		5,060
					T09		5,447
					T10		6,024
					T11		6,605
					T12		7,474
					T31		
					T32		
					T33		
					T34		
					T35		

EXAMPLE

MGGL2020 S2 CB 3554 T00 - TWA101 - S2 - SR340

CODE	SEATER	ARMS	D	W	FABRIC	METAL	\$
MGGL2025	S25	CB	35	62	T00	S2	3,850
					T05		4,768
					T06		4,996
					T07		5,276
					T08		5,730
					T09		6,180
					T10		6,859
					T11		7,534
					T12		8,551
					T31		
					T32		
					T33		
					T34		
					T35		

EXAMPLE

MGGL2025 S25 CB 3562 T00 - TWA101 - S2 - SR340

GLAMOUR - SOFA - 71"

Three seater

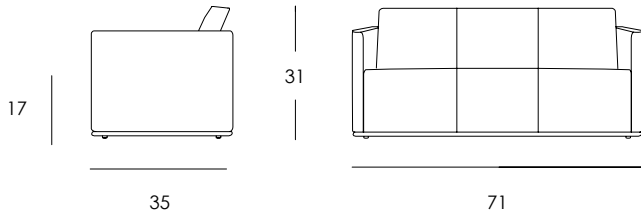

Specifications:

Frame:

Mdf frame covered with polyether

Suspension:

Interlaced elastic webbing

Feet:

Chromed base with 4 casters or 4 metallic feet.

Cover:

Fixed upholstered

Seat:

77 lb. polyether foam

Back:

65 lb. polyether foam

GLAMOUR - OTTOMAN

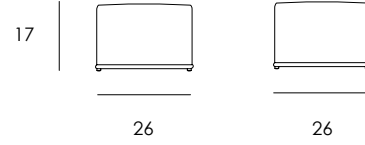

Specifications:

Frame:

Mdf frame covered with polyether

Suspension:

Interlaced elastic webbing

Feet:

Chromed base with 4 casters or 4 metallic feet.

Footstool:

Mdf frame with 77 lb. polyether cushion

Cover:

Fixed upholstered

Seat:

77 lb. polyether foam

CODE	SEATER	ARMS	D	W	FABRIC	METAL	\$
MGGL2030	S3	CB	35	71	T00	S2	4,349
					T05		5,317
					T06		5,559
					T07		5,860
					T08		6,345
					T09		6,827
					T10		7,552
					T11		8,277
					T12		9,363
					T31		
					T32		
					T33		
					T34		
					T35		

EXAMPLE

MGGL2030 S3 CB 3571 T00 - TWA101 - S2 - SR340

CODE	D	W	FABRIC	METAL	\$
MGGL2060	26	26	T00	S2	592
			T05		777
			T06		820
			T07		878
			T08		967
			T09		1,060
			T10		1,196
			T11		1,331
			T12		1,533
			T31		
			T32		
			T33		
			T34		
			T35		

EXAMPLE

MGGL2060 2626 - T00 - TWA101 - S2 - SR340

GRAMMY - ARMCHAIR

One seater

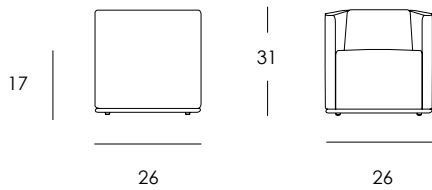

Specifications:

Frame:

Mdf frame covered with polyether

Suspension:

Interlaced elastic webbing

Feet:

Chromed base with 4 metallic feet.

Cover:

Fixed upholstered

Seat:

77 lb. polyether foam

Back:

65 lb. polyether foam

GRAMMY - OTTOMAN

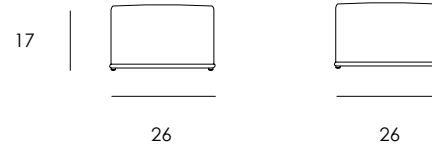

Specifications:

Frame:

Mdf frame covered with polyether

Suspension:

Interlaced elastic webbing

Feet:

Chromed base with 4 metallic feet.

Footstool:

Mdf frame with 77 lb. polyether cushion

Cover:

Fixed upholstered

Seat:

77 lb. polyether foam

CODE	SEATER	ARMS	D	W	FABRIC	METAL	\$
MGGM2010	S1	CB	26	26	T00	S2	1,034
					T05		1,404
					T06		1,493
					T07		1,606
					T08		1,788
					T09		1,970
					T10		2,241
					T11		2,512
					T12		2,920
					T31		
					T32		
					T33		
					T34		
					T35		

EXAMPLE

MGGM2010 S1 CB 2626 T00 - TWA101 - S2 - SR340

CODE	D	W	FABRIC	METAL	\$
MGGM2060	26	26	T00	S2	592
			T05		777
			T06		820
			T07		878
			T08		967
			T09		1,060
			T10		1,196
			T11		1,331
			T12		1,533
			T31		
			T32		
			T33		
			T34		
			T35		

EXAMPLE

MGGM2060 2626 T00 - TWA101 - S2 - SR340

INTERVAL - ARMCHAIR

One seater

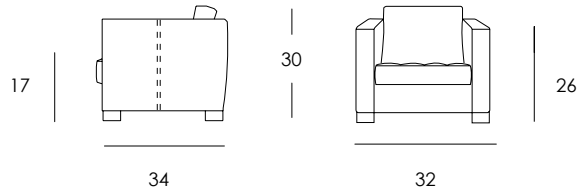

Specifications:

Frame:

Mdf frame covered by polyether.

Suspension:

Interlaced elastic webbing.

Feet:

Metal polished ALUMINUM.

Cover:

Fixed upholstered.

Seat:

77 lb. polyether. (cfc. free)

Back:

66 lb. polyether. (cfc. free)

CODE	SEATER	ARMS	D	W	FABRIC	METAL	\$
MGNL2010	S1	CB	34	32	T00	S2	1,629
					T05		2,648
					T06		2,767
					T07		2,914
					T08		3,151
					T09		3,390
					T10		3,746
					T11		4,104
					T12		4,638
					T31		
					T32		
					T33		
					T34		
					T35		

EXAMPLE

MGNL2010 S1 CB 3432 T00 - TWA101 - S2 - SR340

INTERVAL - SOFA - 57"

Two seater

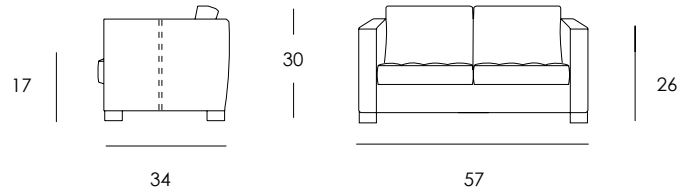

Specifications:

Frame:

Mdf frame covered by polyether.

Suspension:

Interlaced elastic webbing.

Feet:

Metal polished ALUMINUM.

Cover:

Fixed upholstered.

Seat:

77 lb. polyether. (cfc. free)

Back:

66 lb. polyether. (cfc. free)

CODE	SEATER	ARMS	D	W	FABRIC	METAL	\$
MGNL2020	S2	CB	34	57	T00	S2	2,143
					T05		3,064
					T06		3,289
					T07		3,572
					T08		4,026
					T09		4,479
					T10		5,158
					T11		5,836
					T12		6,856
					T31		
					T32		
					T33		
					T34		
					T35		

EXAMPLE

MGNL2020 S2 CB 3457 T00 - TWA101 - S2 - SR340

INTERVAL - SOFA - 80"

Three seater

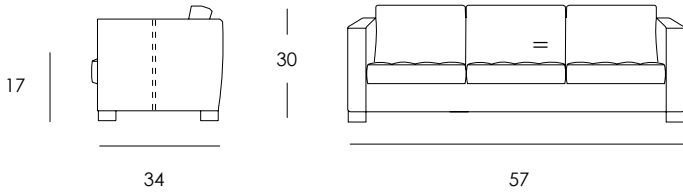

Specifications:

Frame:

Mdf frame covered by polyether.

Suspension:

Interlaced elastic webbing.

Feet:

Metal polished ALUMINUM.

Cover:

Fixed upholstered.

Seat:

77 lb. polyether. (cfc. free)

Back:

66 lb. polyether. (cfc. free)

CODE	SEATER	ARMS	D	W	FABRIC	METAL	\$
MGNL2030	S3	CB	34	80	T00	S2	4,205
					T05		5,071
					T06		5,285
					T07		5,551
					T08		5,975
					T09		6,402
					T10		7,046
					T11		7,953
					T12		9,311
					T31		
					T32		
					T33		
					T34		
					T35		

EXAMPLE

MGNL2030 S3 CB 3480 T00 - TWA101 - S2 - SR340

KANEL - ARMCHAIR

One seater

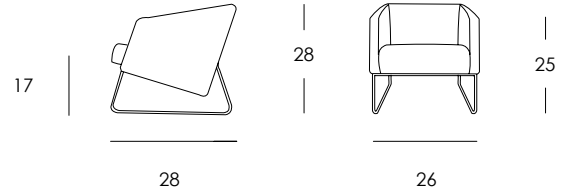

Specifications:

Frame:

Mdf frame covered by polyether.

Suspension:

Interlaced elastic webbing

Feet:

Chromed Metal, 14 mm diameter.

Cover:

Fixed upholstered.

Seat:

77 lb. polyether. (cfc. free)

Back:

66 lb. polyether. (cfc. free)

CODE	SEATER	ARMS	D	W	FABRIC	METAL	\$
MGKN2010	S1	CB	28	26	T00	S2	1,695
					T05		1,990
					T06		2,062
					T07		2,151
					T08		2,299
					T09		2,443
					T10		2,660
					T11		2,876
					T12		3,203
					T31		
					T32		
					T33		
					T34		
					T35		

EXAMPLE

MGKN2010 S1 CB 2826 T00 - TWA101 - S2 - SR340

MADALENA - OTTOMAN

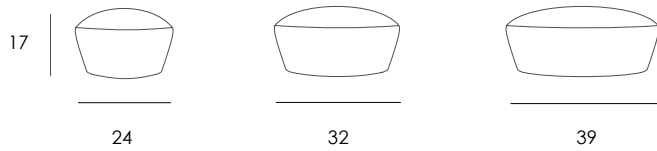

Specifications:

Frame:

Mdf frame covered by polyether.

Feet:

Stainless steel.

Cover:

Fixed upholstered.

Seat:

77 lb. polyether. (cfc. free)

Back:

66 lb. polyether. (cfc. free)

CODE	DIAMETER	FABRIC	FEET	\$
MGMN2060	24	T00	C1	661
		T05		809
		T06		846
		T07		889
		T08		962
		T09		1,034
	T10	1,144		
	T11	1,253		
	T12	1,415		
	32	T31	944	
		T32	1,135	
		T33	1,181	
T34		1,239		
T35		1,331		
		1,427		
39		1,565		
		1,707		
		1,918		
		1,447		
		1,759		
		1,837		
		1,932		
		2,088		
	2,241			
	2,472			
	2,703			
	3,050			

EXAMPLE

MGMN2060 24 T00 - TWA101 - C1 - C413

OPAL - ARMCHAIR

One seater

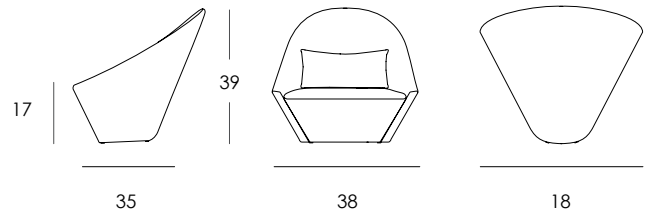

Specifications:

Frame:

Wood frame covered by polyether.

Suspension:

Interlaced elastic webbing

Feet:

Black plastic feet.

Cover:

Fixed upholstered.

Seat:

77 lb. polyether. (cfc. free), covered with acrylic padding.

Back:

55 lb. polyether. (cfc. free), covered with acrylic padding.

KIDNEYCUSHION: combination of 70% antiallergic hollow fibre and 30% down feather.

CODE	SEATER	ARMS	D	W	FABRIC	FEET	\$
MGPL2010	S1	CB	35	38	T00	C1	1,764
					T05		2,281
					T06		2,411
					T07		2,570
					T08		2,824
					T09		3,078
					T10		3,463
					T11		3,844
					T12		4,418
					T31		
					T32		
					T33		
					T34		
					T35		

EXAMPLE

MGPL2010 S1 CB 3538 T00 - TWA101 - C1 - C413

OPALINA - ARMCHAIR

One seater

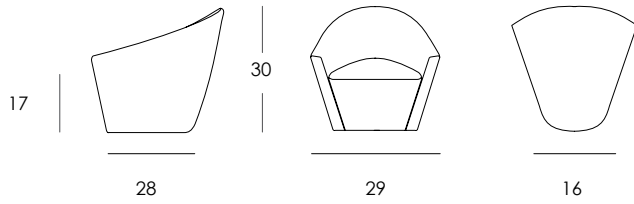

Specifications:

Frame:

Wood frame covered by polyether.

Suspension:

Interlaced elastic webbing

Feet:

Black plastic feet.

Cover:

Fixed upholstered.

Seat:

77 lb. polyether. (cfc. free), covered with acrylic padding.

Back:

55 lb. polyether.

OPEN AIR - SOFA - 65"

Two and a half seater

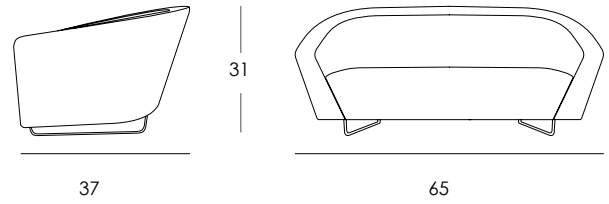

Specifications:

Frame:

Wood frame covered by polyether.

Suspension:

Interlaced elastic webbing

Feet:

Chromed Metal

Cover:

Fixed upholstered.

Seat:

77 lb. polyether. (cfc. free)

Back:

77 lb. polyether. (cfc. free)

CODE	SEATER	ARMS	D	W	FABRIC	METAL	\$
MGAA2010	S1	CB	28	29	T00	C1	1,077
					T05		1,447
					T06		1,539
					T07		1,655
					T08		1,837
					T09		2,019
					T10		2,293
					T11		2,567
					T12		2,977
					T31		
					T32		
					T33		
					T34		
					T35		

EXAMPLE

MGAA2010 S1 CB 2829 T00 - TWA101 - C1 - C413

CODE	SEATER	ARMS	D	W	FABRIC	METAL	\$
MGPR2025	S25	CB	37	65	T00	S2	2,463
					T05		3,200
					T06		3,382
					T07		3,607
					T08		3,968
					T09		4,332
					T10		4,875
					T11		5,418
					T12		6,232
					T31		
					T32		
					T33		
					T34		
					T35		

EXAMPLE

MGPR2025 S25 CB 3765 T00 - TWA101 - S2 - SR340

OPEN AIR - SOFA - 80"

Three seater

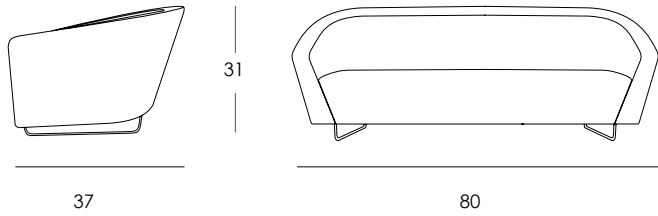

Specifications:

Frame:

Mdf frame covered by polyether.

Suspension:

Interlaced elastic webbing.

Feet:

Stainless steel.

Cover:

Fixed upholstered.

Seat:

77 lb. polyether. (cfc. free)

Back:

77 lb. polyether. (cfc. free)

CODE	SEATER	ARMS	D	W	FABRIC	METAL	\$
MGPR2030	S3	CB	37	80	T00	S2	3,878
					T05		4,984
					T06		5,256
					T07		5,597
					T08		6,140
					T09		6,683
					T10		7,497
					T11		8,311
					T12		9,536
					T31		
					T32		
					T33		
					T34		
					T35		

EXAMPLE

MGPR2030 S3 CB 3780 T00 - TWA101 - S2 - SR340

OPEN AIR - SOFA - 96"

Three and a half seater

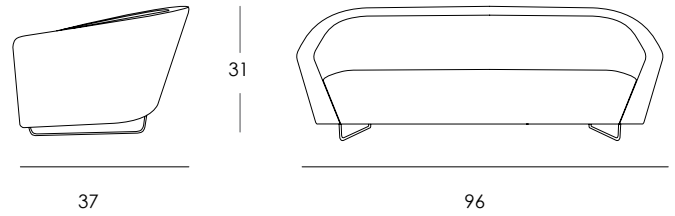

Specifications:

Frame:

Mdf frame covered by polyether.

Suspension:

Interlaced elastic webbing.

Feet:

Stainless steel.

Cover:

Fixed upholstered.

Seat:

77 lb. polyether. (cfc. free)

Back:

77 lb. polyether. (cfc. free)

CODE	SEATER	ARMS	D	W	FABRIC	METAL	\$
MGPR2035	S35	CB	37	96	T00	S2	4,508
					T05		5,675
					T06		5,961
					T07		6,319
					T08		6,893
					T09		7,468
					T10		8,326
					T11		9,186
					T12		10,477
					T31		
					T32		
					T33		
					T34		
					T35		

EXAMPLE

MGPR2035 S35 CB 3796 T00 - TWA101 - S2 - SR340

OXYGEN - SOFA - 70"

Two seater

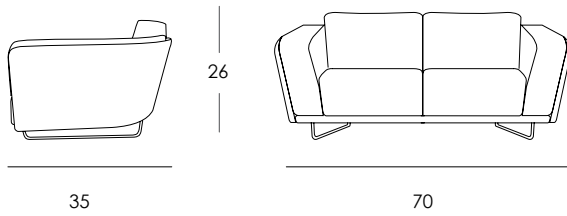

Specifications:

Frame:

Metallic anticorrosion painted

Suspension:

NEA webbing

Feet:

Chromed Metal

Cover:

Fixed upholstered.

Seat:

Visco foam cushion 121 lb. with memory effect + 77 lb. polyether.
With wrinkle control.

Back:

Combination of 70% antiallergic hollow fibre and 30% down feather

Arms:

66 lb. polyether.

CODE	SEATER	ARMS	D	W	FABRIC	METAL	\$
MGXY2020	S2	CB	35	70	T00	S2	3,549
					T05		4,803
					T06		5,112
					T07		5,496
					T08		6,111
					T09		6,729
					T10		7,653
					T11		8,574
					T12		9,960
					T31		
					T32		
					T33		
					T34		
					T35		

EXAMPLE

MGXY2020 S2 CB 3570 T00 - TWA101 - S2 - SR340

OXYGEN - SOFA - 80"

Two and a half seater

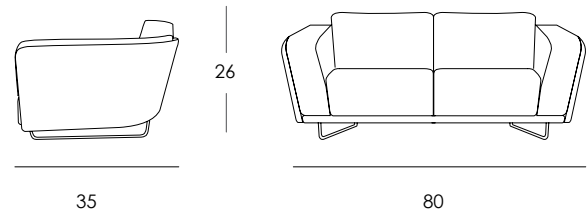

Specifications:

Frame:

Metallic anticorrosion painted

Suspension:

NEA webbing

Feet:

Chromed Metal

Cover:

Fixed upholstered.

Seat:

Visco foam cushion 121 lb. with memory effect + 77 lb. polyether.
With wrinkle control.

Back:

Combination of 70% antiallergic hollow fibre and 30% down feather

Arms:

65 lb. polyether.

CODE	SEATER	ARMS	D	W	FABRIC	METAL	\$
MGXY2025	S25	CB	35	80	T00	S2	4,257
					T05		5,631
					T06		5,969
					T07		6,394
					T08		7,070
					T09		7,745
					T10		8,759
					T11		9,773
					T12		11,294
					T31		
					T32		
					T33		
					T34		
					T35		

EXAMPLE

MGXY2025 S25 CB 3580 T00 - TWA101 - S2 - SR340

OXYGEN - SOFA - 95"

Three and a half seater

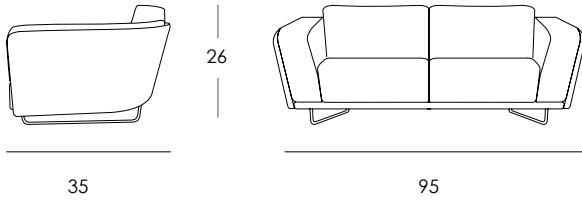

Specifications:

Frame:

Metallic anticorrosion painted

Suspension:

NEA webbing

Feet:

Chromed Metal

Cover:

Completely removable cover

When it is upholstered in leather it is fixed

Seat:

Visco foam cushion 121 lb. with memory effect + 77 lb. polyether.

With wrinkle control.

Back:

Combination of 70% antiallergic hollow fibre and 30% down feather

Arms:

65 lb. polyether.

CODE	SEATER	ARMS	D	W	FABRIC	METAL	\$
MGXY2035	S3	CB	35	95	T00	S2	4,670
					T05		6,143
					T06		6,506
					T07		6,957
					T08		7,682
					T09		8,407
					T10		9,495
					T11		10,581
					T12		12,210
					T31		
					T32		
					T33		
					T34		
					T35		

EXAMPLE

MGXY2035 S3 S3 CB 3595 T00 - TWA101 - S2 - SR340

PARADE - ARMCHAIR

One seater

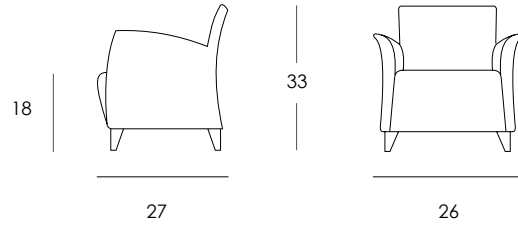

Specifications:

Frame:

Mdf frame covered with polyether.

Suspension:

Interlaced elastic webbing

Feet:

Standard Veneer

Cover:

Fixed upholstered

Seat:

77 lb. polyether. (cfc. free)

Back:

40 and 77 lb. polyether. (cfc. free)

FEET OPTION:

Metallic / Chromed ordered separately.

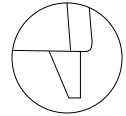

CODE	SEATER	ARMS	D	W	FABRIC	WOOD	\$
MGPD2010	S1	CB	27	26	T00	Z1	910
					T05		1,204
					T06		1,276
					T07		1,366
					T08		1,510
					T09		1,655
					T10		1,874
					T11		2,091
					T12		2,417
					T31		
					T32		
					T33		
					T34		
					T35		
		* FEET CODE		FINISH		\$	
MGPD3020		S1	Metal painted				81
		S2	Chromed				107

EXAMPLE

MGPD3020 S1 - S301

PARODY - ARMCHAIR

One seater

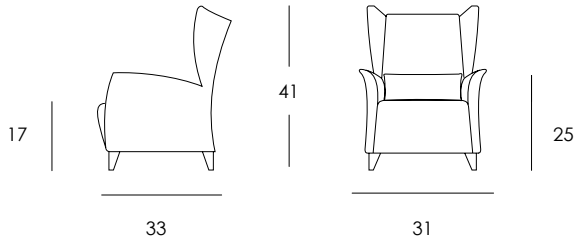

Specifications:

Frame:

Mdf frame covered by polyether.

Suspension:

Interlaced elastic webbing

Feet:

Standard Veneer

Cover:

Fixed upholstered.

Seat:

77 lb. polyether. (cfc. free)

Back:

53 lb. polyether. (cfc. free)

KIDNEYCUSHION: 53 lb. Polyether (cfc. free)

FEET OPTION:

Metallic / Chromed ordered separately.

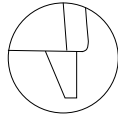

CODE	SEATER	ARMS	D	W	FABRIC	WOOD	\$
MGPY2010	S1	CB	33	31	T00	Z1	1,118
					T05		1,672
					T06		1,808
					T07		1,975
					T08		2,247
					T09		2,521
					T10		2,928
					T11		3,335
					T12		3,945
					T31		
					T32		
					T33		
					T34		
					T35		
* FEET CODE		FINISH				\$	
MGPY3020	S1	Metal painted			81		
		S2	Chromed			107	

EXAMPLE

MGPY3020 S1 - S402

PARODY - OTTOMAN

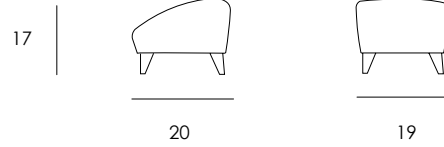

Specifications:

Footstool:

Mdf frame with a 77 lb. polyether cushion. (cfc. free)

Cover:

Fixed upholstered.

Seat:

77 lb. polyether. (cfc. free)

Feet:

Standard Veneer

FEET OPTION:

Metallic / Chromed ordered separately.

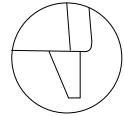

CODE	D	W	FABRIC	WOOD	\$
MGPY2060	20	19	T00	Z1	384
			T05		531
			T06		566
			T07		612
			T08		684
			T09		757
			T10		866
			T11		976
			T12		1,138
			T31		
			T32		
			T33		
			T34		
			T35		

EXAMPLE

MGPY2060 2019 T00 - TWA101 - Z1 - Z501

PLACE - CHAISELOUNGE - RIGHT ARM

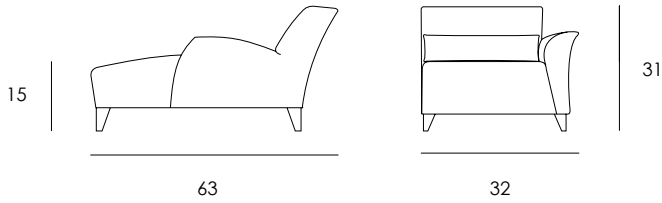

Specifications:

Frame:

Mdf frame covered by polyether.

Suspension:

"Nosag" metallic spring

Feet:

Standard Veneer

Cover:

Fixed upholstered.

Seat:

77 lb. Polyether. (cfc. free)

Back:

53 lb. Polyether. (cfc. free)

KIDNEYCUSHION: 53 lb. Polyether.

FEET OPTION:

Metallic / Chromed ordered separately.

CODE	ARMS	D	W	FABRIC	WOOD	\$
MGPA2070	BD	63	32	T00	Z1	2,556
				T05		3,107
				T06		3,243
				T07		3,413
				T08		3,685
				T09		3,956
				T10		4,364
				T11		4,771
				T12		5,383
				T31		
				T32		
				T33		
				T34		
				T35		
				*FEET CODE		FINISH

MGPA3020	S1	Metal painted	81
	S2	Chromed	107

EXAMPLE

MGPA3020 S1 - S402

PLACE - CHAISELOUNGE - LEFT ARM

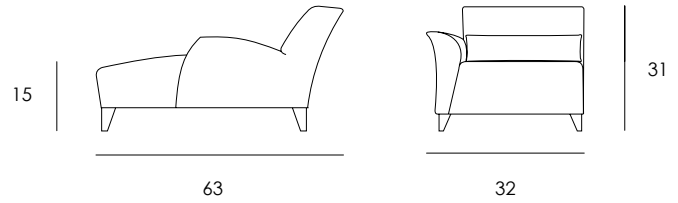

Specifications:

Frame:

Mdf frame covered by polyether.

Suspension:

"Nosag" metallic spring

Feet:

Veneer

Cover:

Fixed upholstered.

Seat:

77 lb. Polyether. (cfc. free)

Back:

53 lb. Polyether. (cfc. free)

KIDNEYCUSHION: 53 lb. Polyether.

FEET OPTION:

Metallic / Chromed ordered separately.

CODE	ARMS	D	W	FABRIC	WOOD	\$
MGPA2071	BI	63	32	T00	Z1	2,556
				T05		3,107
				T06		3,243
				T07		3,413
				T08		3,685
				T09		3,956
				T10		4,364
				T11		4,771
				T12		5,383
				T31		
				T32		
				T33		
				T34		
				T35		
				*FEET CODE		FINISH

EXAMPLE

MGPA2071 BI 6332 T00 - TWA101 - Z1 - Z501

RINGO - ARMCHAIR

One seater

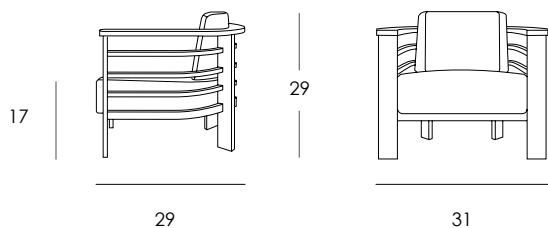

Specifications:

Frame:

Mdf frame.

Feet and Arms:

Mdf varnished in wengue.

Seat:

77 lb. Polyether

Back:

77 lb. Polyether

RIVERSO - CHAIR

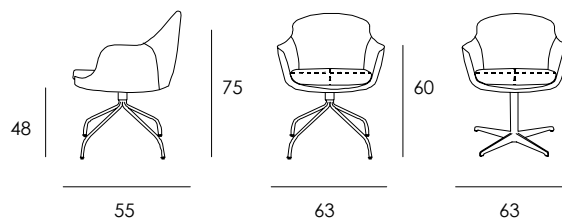

Specifications:

Frame:

Steel framework.

Feet:

Metallic swivel mechanism (P10).

Star-shaped base (R1).

Cover:

Fix upholstered.

Seat and back:

Rigid polyurethane, entirely moulded in cold-cure polyurethane.

CODE	SEATER	ARMS	D	W	FABRIC	WOOD	\$
MGRG2010	S1	CB	29	32	T00	Z1	3,286
					T05		3,555
					T06		3,621
					T07		3,705
					T08		3,838
					T09		3,971
					T10		4,170
					T11		4,369
					T12		4,670
					T31		
					T32		
					T33		
					T34		
					T35		

EXAMPLE

MGRG2010 S1 CB 2932 T00 - TWA101 - Z1 - Z501

CODE	SEATER	ARMS	D	W	BASE	FABRIC	METAL	\$
MGRR2010	S1	CB	24	25	P10	T00	S2	725
						T05		944
						T06		999
						T07		1,069
						T08		1,175
						T09		1,285
						T10		1,447
						T11		1,611
						T12		1,854
						T31		
						T32		1,025
					R1	T33		1,245
						T34		1,300
						T35		1,369
								1,476
								1,585
								1,747
								1,912
								2,154

EXAMPLE

MGRR2010 S1 CB 2425 P10 T00 - TWA101 - S2 - S315

ROSETTA - ARMCHAIR

One seater

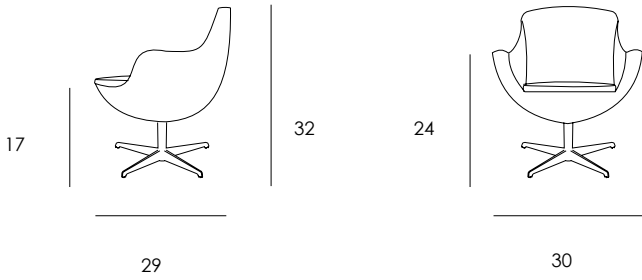

Specifications:

Frame:

Steel framework.

Feet:

Continuos mecanism

Cover:

Fixed upholstered.

Seat and back entirely moulded in cold-cure polyurethane.

ROSETTA - OTTOMAN

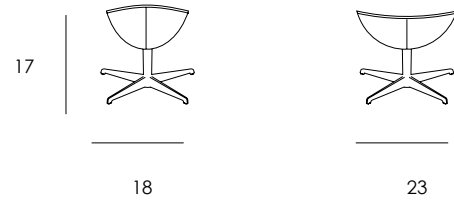

Specifications:

Frame:

Steel framework.

Feet:

Continuos mecanism

Cover:

Fixed upholstered.

Seat entirely moulded in cold-cure polyurethane.

CODE	SEATER	ARMS	D	W	FABRIC	METAL	\$
MGTR2010	S1	CB	29	30	T00	S2	1,074
					T05		1,455
					T06		1,551
					T07		1,669
					T08		1,857
					T09		2,045
					T10		2,328
					T11		2,611
					T12		3,035
					T31		
					T32		
					T33		
					T34		
					T35		

EXAMPLE

MGTR2010 S1 CB 2930 T00 - TWA101 - S2 - SR340

CODE	D	W	FABRIC	METAL	\$
MGTR2060	18	23	T00	S2	783
			T05		930
			T06		967
			T07		1,014
			T08		1,086
			T09		1,158
			T10		1,268
			T11		1,375
			T12		1,539
			T31		
			T32		
			T33		
			T34		
			T35		

EXAMPLE

MGTR2060 1823 T00 - TWA101 - S2 - SR340

SERIA - SOFA - 73"

Two and a half seater

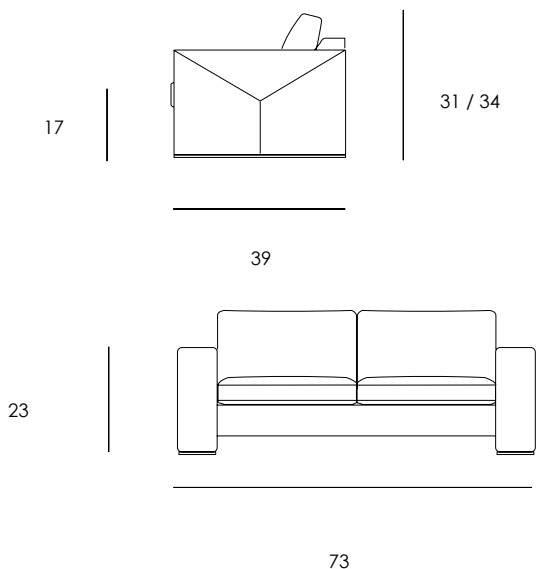

Specifications:

Frame:

Metallic anticorrosion painted, covered by polyether.
Available with MMS intelligent suspension system (with an upcharge)

Suspension:

Interlaced elastic webbing NEA

Cover:

Fixed upholstered

Seat:

Molded injected polyurethane upholstered with cotton casing

Back:

Silicon fiber

CODE	SEATER	ARMS	D	W	FABRIC	METAL	\$
MGSR2025	S25	CB	39	73	T00	S2	4,442
					T05		5,825
					T06		6,166
					T07		6,590
					T08		7,272
					T09		7,953
					T10		8,973
					T11		9,992
					T12		11,526
					T31		
					T32		
					T33		
					T34		
					T35		

EXAMPLE

MGSR2025 S25 CB 3973 T00 - TWA101 - S2 - SR340

SERIA - SOFA - 82"

Three seater

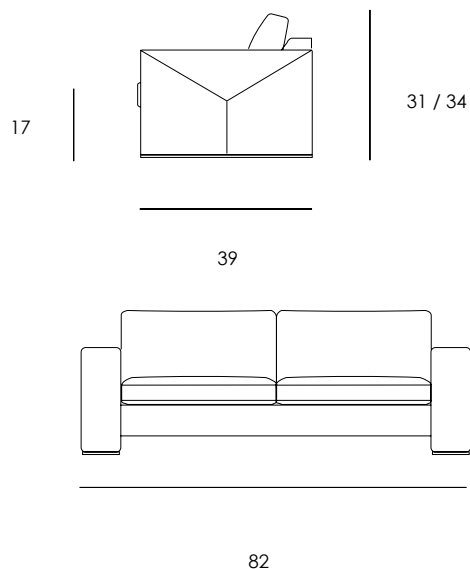

Specifications:

Frame:

Metallic anticorrosion painted, covered by polyether.
Available with MMS intelligent suspension system (with an upcharge)

Suspension:

Interlaced elastic webbing NEA

Cover:

Fixed upholstered

Seat:

Molded injected polyurethane upholstered with cotton casing

Back:

Silicon fiber

CODE	SEATER	ARMS	D	W	FABRIC	METAL	\$
MGSR2030	S3	CB	39	82	T00	S2	4,690
					T05		6,128
					T06		6,480
					T07		6,922
					T08		7,630
					T09		8,334
					T10		9,394
					T11		10,454
					T12		12,045
					T31		
					T32		
					T33		
					T34		
					T35		

EXAMPLE

MGSR2030 S3 CB 3982 T00 - TWA101 - S2 - SR340

SERIA - SOFA - 90"

Three and a half seater

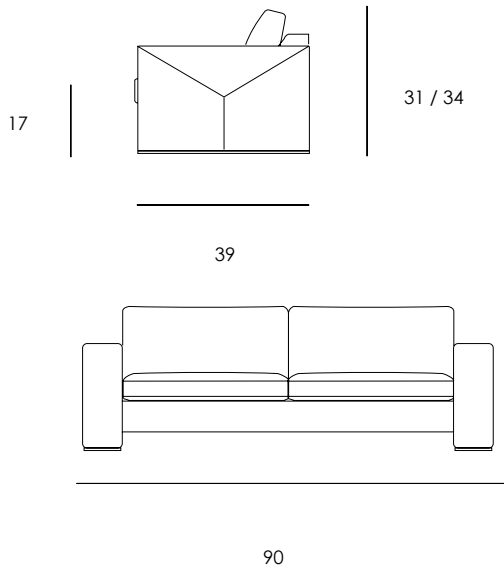

Specifications:

Frame:

Metallic anticorrosion painted, covered by polyether.
Available with MMS intelligent suspension system (with an upcharge)

Suspension:

Interlaced elastic webbing NEA

Cover:

Fixed upholstered

Seat:

Molded injected polyurethane upholstered with cotton casing

Back:

Molded injected polyurethane upholstered with cotton casing

CODE	SEATER	ARMS	D	W	FABRIC	METAL	\$
MGSR2035	S35	CB	39	90	T00	S2	8,236
					T05		9,556
					T06		9,879
					T07		10,287
					T08		10,936
					T09		11,583
					T10		12,559
					T11		13,533
					T12		14,994
					T31		
					T32		
					T33		
					T34		
					T35		

EXAMPLE

MGSR2035 S35 CB 3990 T00 - TWA101 - S2 - SR340

TRANSIT - CORNER

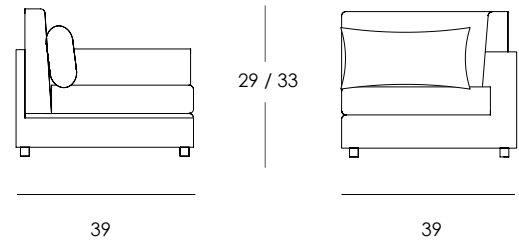

Specifications:

Frame:

Metallic anticorrosion painted, covered by polyether.
Available with MMS intelligent suspension system (with an upcharge)

Suspension:

Interlaced elastic webbing NEA

Cover:

Fixed upholstered

Seat:

Molded injected polyurethane upholstered with cotton casing

Back:

Molded injected polyurethane upholstered with cotton casing

CODE	D	W	FABRIC	WOOD	\$
MGTR2050	39	39	T00	Z1	2,108
			T05		3,090
			T06		3,333
			T07		3,633
			T08		4,118
			T09		4,600
			T10		5,325
			T11		6,050
			T12		7,136
			T31		
			T32		
			T33		
			T34		
			T35		

EXAMPLE

MGTR2050 3939 T00 - TWA101 - Z1 - Z501

TRANSIT - ARMCHAIR - ARMLESS

One seater

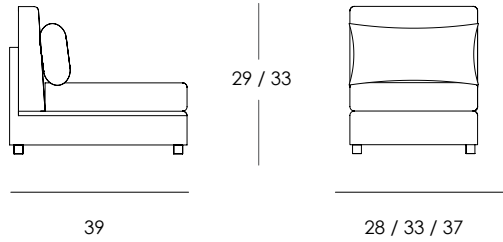

Specifications:

Frame:

Metallic anticorrosion painted, covered by polyether.
Available with MMS intelligent suspension system (with an upcharge)

Suspension:

Interlaced elastic webbing NEA

Cover:

Fixed upholstered

Seat:

Molded injected polyurethane upholstered with cotton casing

Back:

Molded injected polyurethane upholstered with cotton casing

Feet:

Veneer

CODE	SEATER	ARMS	D	W	FABRIC	WOOD	\$	
MGTR2013	S1	SB	39	28	T00	Z1	1,490	
					T05		2,192	
					T06		2,362	
					T07		2,579	
					T08		2,923	
					T09		3,266	
					T10		3,783	
					T11		4,300	
					T12		5,074	
					33	T31		1,666
						T32		2,414
						T33		2,599
	T34		2,827					
	T35		3,197					
			3,564					
			4,118					
			4,670					
			5,499					
	37			1,785				
				2,559				
				2,749				
				2,986				
				3,367				
				3,748				
		4,317						
		4,889						
		5,744						

EXAMPLE

MGTR2013 S1 SB 3928 T00 - TWA101 - Z1 - Z501

TRANSIT - SOFA 49" - ARMLESS

Two seater

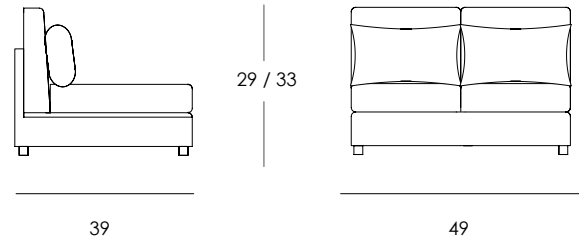

Specifications:

Frame:

Metallic anticorrosion painted, covered by polyether.
Available with MMS intelligent suspension system (with an upcharge)

Suspension:

Interlaced elastic webbing NEA

Cover:

Fixed upholstered

Seat:

Molded injected polyurethane upholstered with cotton casing

Back:

Molded injected polyurethane upholstered with cotton casing

Feet:

Veneer

CODE	SEATER	ARMS	D	W	FABRIC	WOOD	\$	
MGTR2023	S2	SB	39	49	T00	Z1	2,452	
					T05		3,777	
					T06		4,104	
					T07		4,511	
					T08		5,164	
					T09		5,816	
					T10		6,792	
					T11		7,771	
					T12		9,238	
					39	T31		
						T32		
						T33		
	T34							
	T35							

EXAMPLE

MGTR2023 S2 SB 3949 T00 - TWA101 - Z1 - Z501

TRANSIT - SOFA 57" - ARMLESS

Two and a half seater

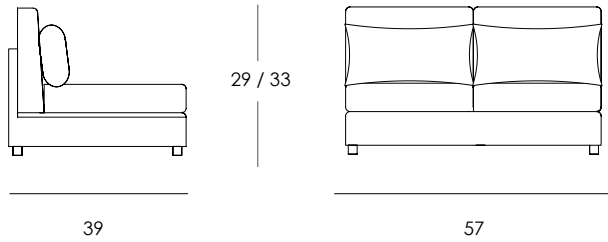

Specifications:

Frame:

Metallic anticorrosion painted, covered by polyether.
Available with MMS intelligent suspension system (with an upcharge)

Suspension:

Interlaced elastic webbing NEA

Cover:

Fixed upholstered

Seat:

Molded injected polyurethane upholstered with cotton casing

Back:

Molded injected polyurethane upholstered with cotton casing

Feet:

Veneer

CODE	SEATER	ARMS	D	W	FABRIC	WOOD	\$
MGTR2033	S25	SB	39	57	T00	Z1	2,720
					T05		4,121
					T06		4,465
					T07		4,895
					T08		5,582
					T09		6,270
					T10		7,303
					T11		8,334
					T12		9,885
					T31		
					T32		
					T33		
					T34		
T35							

EXAMPLE

MGTR2028 S25 SB 3957 T00 - TWA101 - Z1 - Z501

TRANSIT - SOFA 65" - ARMLESS

Three seater

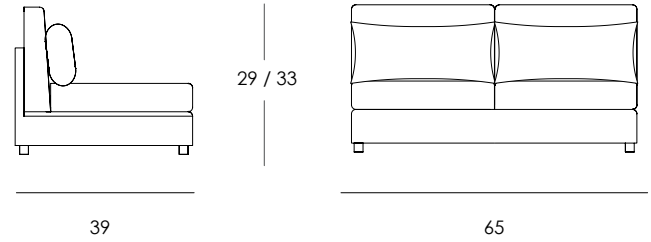

Specifications:

Frame:

Metallic anticorrosion painted, covered by polyether.
Available with MMS intelligent suspension system (with an upcharge)

Suspension:

Interlaced elastic webbing NEA

Cover:

Fixed upholstered

Seat:

Molded injected polyurethane upholstered with cotton casing

Back:

Molded injected polyurethane upholstered with cotton casing

Feet:

Veneer

CODE	SEATER	ARMS	D	W	FABRIC	WOOD	\$
MGTR2033	S3	SB	39	65	T00	Z1	3,001
					T05		4,499
					T06		4,869
					T07		5,328
					T08		6,065
					T09		6,804
					T10		7,907
					T11		9,013
					T12		10,671
					T31		
					T32		
					T33		
					T34		
T35							

EXAMPLE

MGTR2033 S3 SB 3965 T00 - TWA101 - Z1 - Z501

TRANSIT - SOFA 73" - ARMLESS

Three and a half seater

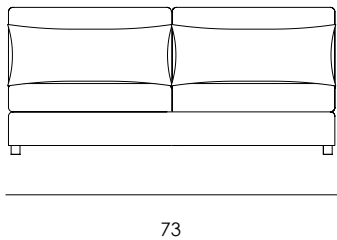
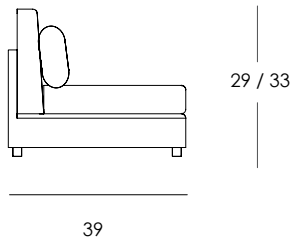

Specifications:

Frame:

Metallic anticorrosion painted, covered by polyether.
Available with MMS intelligent suspension system (with an upcharge)

Suspension:

Interlaced elastic webbing NEA

Cover:

Fixed upholstered

Seat:

Molded injected polyurethane upholstered with cotton casing

Back:

Molded injected polyurethane upholstered with cotton casing

Feet:

Veneer

CODE	SEATER	ARMS	D	W	FABRIC	WOOD	\$
MGTR2038	S35	SB	39	73	T00	Z1	3,286
					T05		4,834
					T06		5,216
					T07		5,692
					T08		6,452
					T09		7,214
					T10		8,355
					T11		9,495
					T12		11,205
					T31		
					T32		
					T33		
					T34		
					T35		

EXAMPLE

MGTR2038 S35 SB 3973 T00 - TWA101 - Z1 - Z501

TRANSIT - SOFA 85" - ARMLESS

Four seater

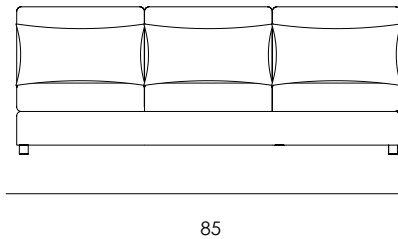
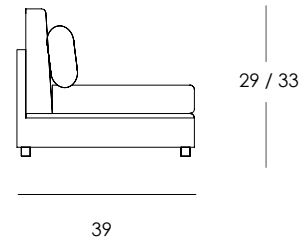

Specifications:

Frame:

Metallic anticorrosion painted, covered by polyether.
Available with MMS intelligent suspension system (with an upcharge)

Suspension:

Interlaced elastic webbing NEA

Cover:

Fixed upholstered

Seat:

Molded injected polyurethane upholstered with cotton casing

Back:

Molded injected polyurethane upholstered with cotton casing

Feet:

Veneer

CODE	SEATER	ARMS	D	W	FABRIC	WOOD	\$
MGTR2043	S4	SB	39	85	T00	Z1	4,011
					T05		6,163
					T06		6,691
					T07		7,350
					T08		8,407
					T09		9,464
					T10		11,049
					T11		12,634
					T12		15,011
					T31		
					T32		
					T33		
					T34		
					T35		

EXAMPLE

MGTR2043 S4 SB 3985 T00 - TWA101 - Z1 - Z501

TRANSIT - SOFA 98" - ARMLESS

Four seater

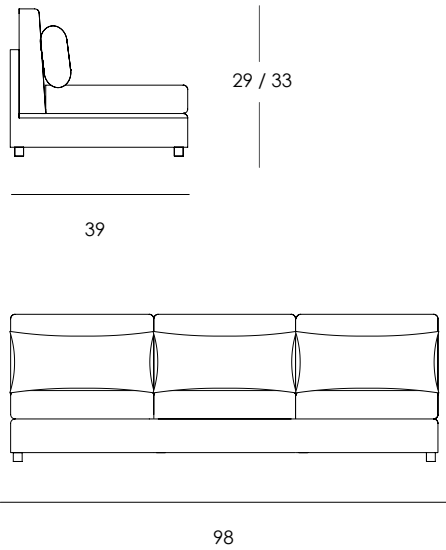

Specifications:

Frame:

Metallic anticorrosion painted, covered by polyether.
Available with MMS intelligent suspension system (with an upcharge)

Suspension:

Interlaced elastic webbing NEA

Cover:

Fixed upholstered

Seat:

Molded injected polyurethane upholstered with cotton casing

Back:

Molded injected polyurethane upholstered with cotton casing

Feet:

Veneer

CODE	SEATER	ARMS	D	W	FABRIC	WOOD	\$
MGTR2048	S45	SB	39	98	T00	Z1	4,306
					T05		6,555
					T06		7,107
					T07		7,797
					T08		8,903
					T09		10,006
					T10		11,664
					T11		13,322
					T12		15,808
					T31		
					T32		
					T33		
					T34		
					T35		

EXAMPLE

MGTR2048 S45 SB 3998 T00 - TWA101 - Z1 - Z501

TRANSIT - SOFA 110" - ARMLESS

Five seater

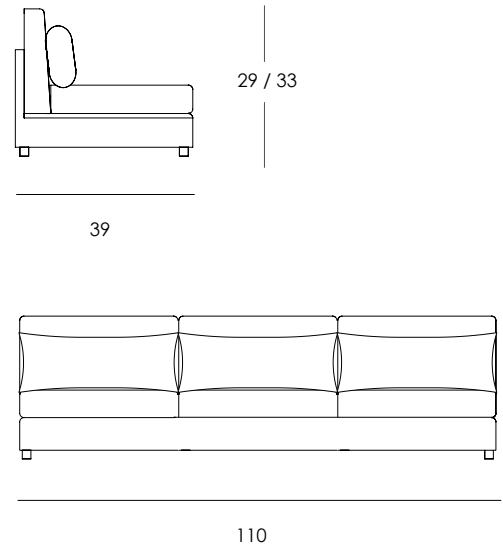

Specifications:

Frame:

Metallic anticorrosion painted, covered by polyether.
Available with MMS intelligent suspension system (with an upcharge)

Suspension:

Interlaced elastic webbing NEA

Cover:

Fixed upholstered

Seat:

Molded injected polyurethane upholstered with cotton casing

Back:

Molded injected polyurethane upholstered with cotton casing

Feet:

Veneer

CODE	SEATER	ARMS	D	W	FABRIC	WOOD	\$
MGTR2053	S5	SB	39	110	T00	Z1	4,566
					T05		6,888
					T06		7,457
					T07		8,170
					T08		9,311
					T09		10,451
					T10		12,164
					T11		13,876
					T12		16,444
					T31		
					T32		
					T33		
					T34		
					T35		

EXAMPLE

MGTR2053 S5 SB 39110 T00 - TWA101 - Z1 - Z501

TRANSIT - CHAISELOUNGE - RIGHT ARM

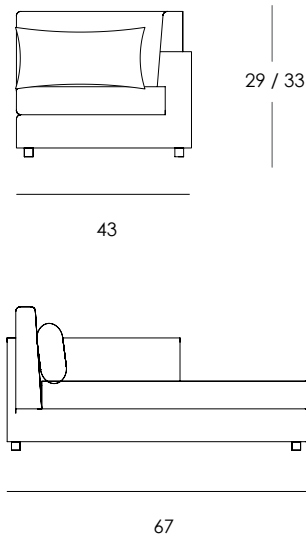

Specifications:

Frame:

Metallic anticorrosion painted, covered by polyether.
Available with MMS intelligent suspension system (with an upcharge)

Suspension:

Interlaced elastic webbing NEA

Cover:

Fixed upholstered

Seat:

Molded injected polyurethane upholstered with cotton casing

Back:

Molded injected polyurethane upholstered with cotton casing

Feet:

Veneer

CODE	ARMS	D	W	FABRIC	WOOD	\$
MGTR2070	BD	67	43	T00	Z1	2,619
				T05		3,616
				T06		3,858
				T07		4,164
				T08		4,655
				T09		5,143
				T10		5,877
				T11		6,610
				T12		7,711
				T31		
				T32		
				T33		
				T34		
				T35		

EXAMPLE

MGTR2070 BD 6743 T00 - TWA101 - Z1 - Z501

TRANSIT - CHAISELOUNGE - LEFT ARM

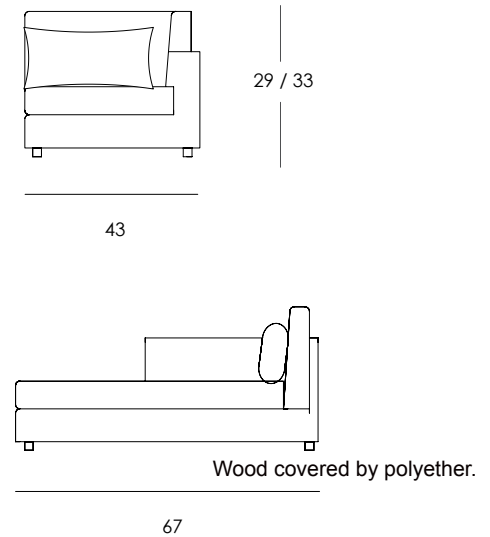

Specifications:

Frame:

Metallic anticorrosion painted, covered by polyether.
Available with MMS intelligent suspension system (with an upcharge)

Suspension:

Interlaced elastic webbing NEA

Cover:

Fixed upholstered

Seat:

Molded injected polyurethane upholstered with cotton casing

Back:

Molded injected polyurethane upholstered with cotton casing

Feet:

Veneer

CODE	ARMS	D	W	FABRIC	WOOD	\$
MGTR2071	BI	67	43	T00	Z1	2,619
				T05		3,616
				T06		3,858
				T07		4,164
				T08		4,655
				T09		5,143
				T10		5,877
				T11		6,610
				T12		7,711
				T31		
				T32		
				T33		
				T34		
				T35		

EXAMPLE

MGTR2071 BI 6743 T00 - TWA101 - Z1 - Z501

TRANSIT - CORNER CHAISELOUNGE

Right Arm

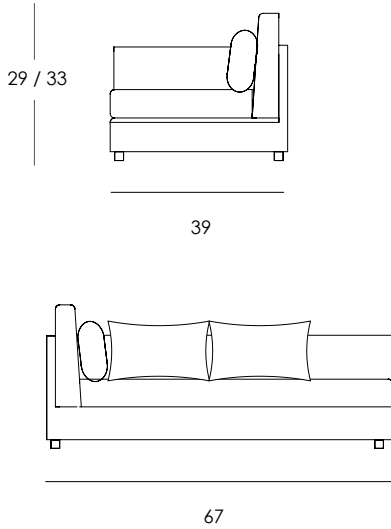

Specifications:

Frame:

Metallic anticorrosion painted, covered by polyether.
Available with MMS intelligent suspension system (with an upcharge)

Suspension:

Interlaced elastic webbing NEA

Cover:

Fixed upholstered

Seat:

Molded injected polyurethane upholstered with cotton casing

Back:

Molded injected polyurethane upholstered with cotton casing

Feet:

Veneer

CODE	ARMS	D	W	FABRIC	WOOD	\$
MGTR2075	BD	34	79	T00	Z1	3,226
				T05		4,491
				T06		4,800
				T07		5,190
				T08		5,810
				T09		6,434
				T10		7,367
				T11		8,300
				T12		9,697
				T31		
				T32		
				T33		
				T34		
				T35		

EXAMPLE

MGTR2075 BD 3479 T00 - TWA101 - Z1 - Z501

TRANSIT - CORNER CHAISELOUNGE

Left Arm

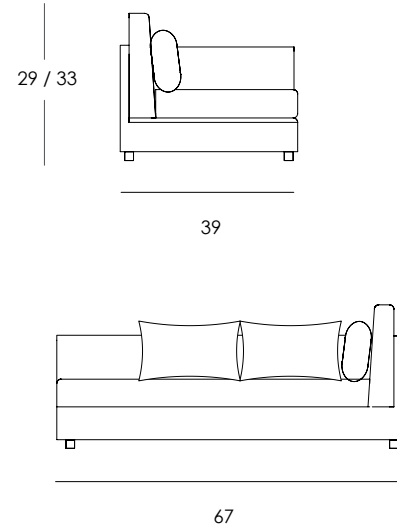

Specifications:

Frame:

Metallic anticorrosion painted, covered by polyether.
Available with MMS intelligent suspension system (with an upcharge)

Suspension:

Interlaced elastic webbing NEA

Cover:

Fixed upholstered

Seat:

Molded injected polyurethane upholstered with cotton casing

Back:

Molded injected polyurethane upholstered with cotton casing

Feet:

Veneer

CODE	ARMS	D	W	FABRIC	WOOD	\$		
MGTR2076	BI	34	79		Z1	3,226		
						4,491		
						4,800		
						5,190		
						5,810		
						6,434		
						7,367		
						8,300		
						9,697		
							T31	
							T32	
							T33	
							T34	
							T35	

EXAMPLE

MGTR2076 BI 3479 T00 - TWA101 - Z1 - Z501

TRANSIT - RIGHT ARM

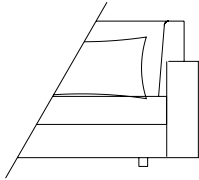

Specifications:

Wood covered by polyether.

CODE	ARMS	D	W	FABRIC	\$
MGTR2090	BD	39	10	T00	422
				T05	638
				T06	690
				T07	757
				T08	863
				T09	967
				T10	1,126
				T11	1,285
				T12	1,522
				T31	
				T32	
				T33	
				T34	
T35					

EXAMPLE

MGTR2090 BD 3910 T00 - TWA101

TRANSIT - LEFT ARM

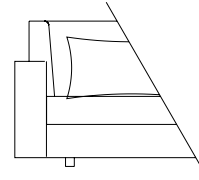

Specifications:

Wood covered by polyether.

CODE	ARMS	D	W	FABRIC	\$
MGTR2091	BI	39	10	T00	422
				T05	638
				T06	690
				T07	757
				T08	863
				T09	967
				T10	1,126
				T11	1,285
				T12	1,522
				T31	
				T32	
				T33	
				T34	
T35					

EXAMPLE

MGTR2091 BI 3910 T00 - TWA101

TRANSIT - upholstered right end panel

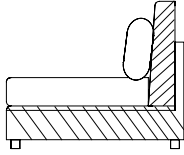

Specifications:

Wood covered by polyether.

CODE	ARMS	D	FABRIC	\$
MGTR8060	BD	39	T00	20
			T05	40
			T06	43
			T07	49
			T08	61
			T09	69
			T10	84
			T11	98
			T12	121
			T31	
			T32	
			T33	
			T34	
			T35	

EXAMPLE

MGTR8060 BD 39 T00 - TWA101

TRANSIT - upholstered left end panel

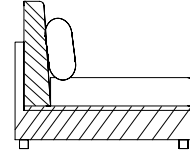

Specifications:

Wood covered by polyether.

CODE	ARMS	D	FABRIC	WOOD	\$
MGTR8061	BI	39	T00	Z1	20
			T05		40
			T06		43
			T07		49
			T08		61
			T09		69
			T10		84
			T11		98
			T12		121
			T31		
			T32		
			T33		
			T34		
			T35		

EXAMPLE

MGTR8061 BI 39 T00 - TWA101

MMS VIP - ARMCHAIR - ARMLESS

One seater

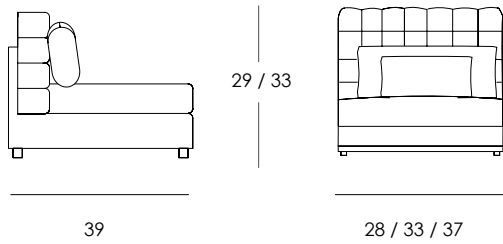

Specifications:

Frame:

Metallic anticorrosion painted, covered by polyether.
Available with MMS intelligent suspension system (with an upcharge)

Suspension:

Interlaced elastic webbing NEA

Cover:

Fixed upholstered

Seat:

Molded injected polyurethane upholstered with cotton casing

Back:

Molded injected polyurethane upholstered with cotton casing

Feet:

Oval metallic feet. Height 6 cm.

CODE	SEATER	ARMS	D	W	FABRIC	METAL	
MGVM2013	S1	SB	39	28	T00	S2	1,920
					T05	2,717	
					T06	2,914	
					T07	3,159	
					T08	3,552	
					T09	3,945	
					T10	4,534	
					T11	5,123	
					T12	6,004	
					33	T31	2,134
						T32	3,029
						T33	3,252
	T34	3,526					
	T35	3,968					
	4,407						
	5,068						
	5,730						
	6,723						
	37	2,264					
		3,174					
		3,396					
		3,676					
		4,124					
	4,569						
	5,239						
5,909							
6,916							

EXAMPLE

MGVM2013 S1 SB 3933 T00 - TWA101 - S2 - SR340

MMS VIP - SOFA 49" - ARMLESS

Two seater

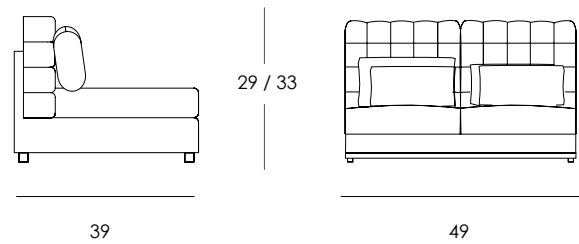

Specifications:

Frame:

Metallic anticorrosion painted, covered by polyether.
Available with MMS intelligent suspension system (with an upcharge)

Suspension:

Interlaced elastic webbing NEA

Cover:

Fixed upholstered

Seat:

Molded injected polyurethane upholstered with cotton casing

Back:

Molded injected polyurethane upholstered with cotton casing

Feet:

Oval metallic feet. Height 6 cm.

CODE	SEATER	ARMS	D	W	FABRIC	METAL	\$
MGVM2023	S2	SB	39	49	T00	S2	2,977
					T05	4,453	
					T06	4,814	
					T07	5,267	
					T08	5,992	
					T09	6,717	
					T10	7,803	
					T11	8,889	
					T12	10,521	
					T31		
					T32		
					T33		
	T34						
	T35						

EXAMPLE

MGVM2023 S2 SB 3949 T00 - TWA101 - S2 - SR340

MMS VIP - SOFA 57" - ARMLESS

Two and a half seater

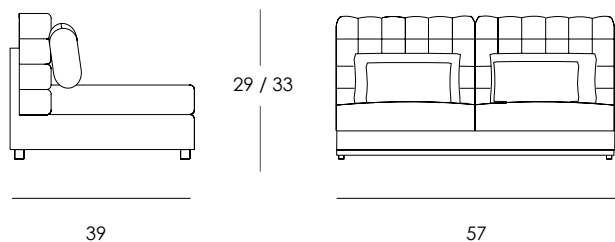

Specifications:

Frame:

Metallic anticorrosion painted, covered by polyether.
Available with MMS intelligent suspension system (with an upcharge)

Suspension:

Interlaced elastic webbing NEA

Cover:

Fixed upholstered

Seat:

Molded injected polyurethane upholstered with cotton casing

Back:

Molded injected polyurethane upholstered with cotton casing

Feet:

Oval metallic feet. Height 6 cm.

MMS VIP - SOFA 65" - ARMLESS

Three seater

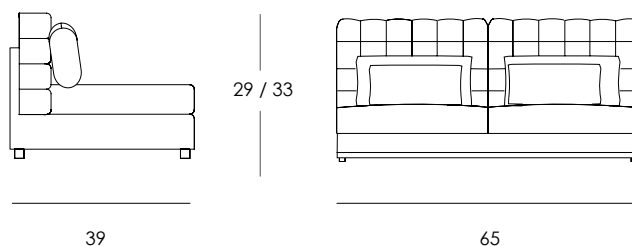

Specifications:

Frame:

Metallic anticorrosion painted, covered by polyether.
Available with MMS intelligent suspension system (with an upcharge)

Suspension:

Interlaced elastic webbing NEA

Cover:

Fixed upholstered

Seat:

Molded injected polyurethane upholstered with cotton casing

Back:

Molded injected polyurethane upholstered with cotton casing

Feet:

Oval metallic feet. Height 6 cm.

CODE	SEATER	ARMS	D	W	FABRIC	METAL	\$
MGVM2028	S25	SB	39	57	T00	S2	3,353
					T05		4,927
					T06		5,314
					T07		5,796
					T08		6,570
					T09		7,341
					T10		8,502
					T11		9,660
					T12		11,398
					T31		
					T32		
					T33		
					T34		
					T35		

EXAMPLE

MGVM2028 S25 SB 3957 T00 - TWA101 - S2 - SR340

CODE	SEATER	ARMS	D	W	FABRIC	METAL	\$
MGVM2033	S3	SB	39	65	T00	S2	3,746
					T05		5,539
					T06		5,978
					T07		6,529
					T08		7,410
					T09		8,294
					T10		9,614
					T11		10,936
					T12		12,920
					T31		
					T32		
					T33		
					T34		
					T35		

EXAMPLE

MGVM2033 S3 SB 3965 T00 - TWA101 - S2 - SR340

MMS VIP - SOFA 73" - ARMLESS

Three and a half seater

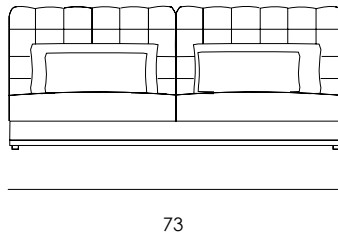
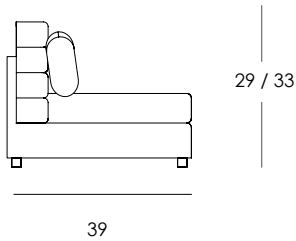

Specifications:

Frame:

Metallic anticorrosion painted, covered by polyether.
Available with MMS intelligent suspension system (with an upcharge)

Suspension:

Interlaced elastic webbing NEA

Cover:

Fixed upholstered

Seat:

Molded injected polyurethane upholstered with cotton casing

Back:

Molded injected polyurethane upholstered with cotton casing

Feet:

Oval metallic feet. Height 6 cm.

CODE	SEATER	ARMS	D	W	FABRIC	METAL	\$
MGVM2038	S35	SB	39	73	T00	S2	4,153
					T05		6,278
					T06		6,801
					T07		7,454
					T08		8,499
					T09		9,544
					T10		11,110
					T11		12,678
					T12		15,026
					T31		
					T32		
					T33		
					T34		
					T35		

EXAMPLE

MGVM2038 S35 SB 3973 T00 - TWA101 - S2 - SR340

MMS VIP - SOFA 85" - ARMLESS

Four seater

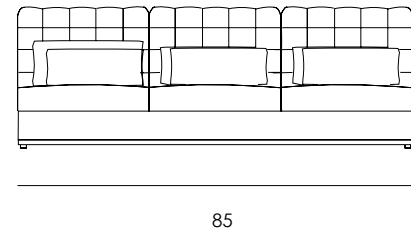
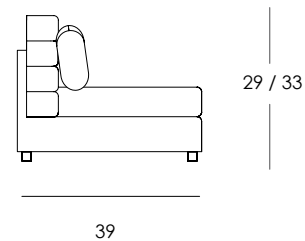

Specifications:

Frame:

Metallic anticorrosion painted, covered by polyether.
Available with MMS intelligent suspension system (with an upcharge)

Suspension:

Interlaced elastic webbing NEA

Cover:

Fixed upholstered

Seat:

Molded injected polyurethane upholstered with cotton casing

Back:

Molded injected polyurethane upholstered with cotton casing

Feet:

Oval metallic feet. Height 6 cm.

CODE	SEATER	ARMS	D	W	FABRIC	METAL	\$
MGVM2043	S4	SB	39	85	T00	S2	4,846
					T05		7,500
					T06		8,150
					T07		8,967
					T08		10,269
					T09		11,575
					T10		13,530
					T11		15,488
					T12		18,422
					T31		
					T32		
					T33		
					T34		
					T35		

EXAMPLE

MGVM2043 S4 SB 3985 T00 - TWA101 - S2 - SR340

MMS VIP - SOFA 98" - ARMLESS

Four seater

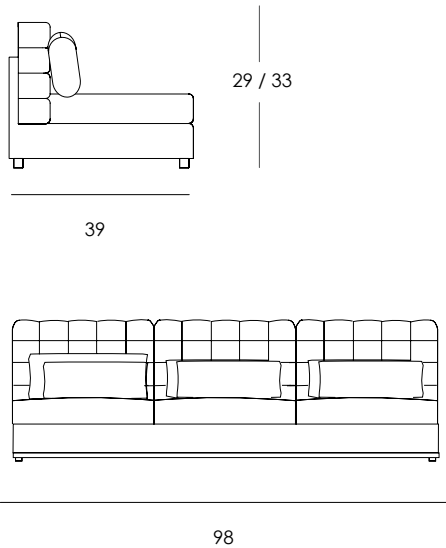

Specifications:

Frame:

Metallic anticorrosion painted, covered by polyether.
Available with MMS intelligent suspension system (with an upcharge)

Suspension:

Interlaced elastic webbing NEA

Cover:

Fixed upholstered

Seat:

Molded injected polyurethane upholstered with cotton casing

Back:

Molded injected polyurethane upholstered with cotton casing

Feet:

Oval metallic feet. Height 6 cm.

CODE	SEATER	ARMS	D	W	FABRIC	METAL	\$
MGVM2048	S45	SB	39	98	T00	S2	5,565
					T05		8,747
					T06		9,530
					T07		10,506
					T08		12,071
					T09		13,634
					T10		15,979
					T11		18,326
					T12		21,844
					T31		
					T32		
					T33		
					T34		
					T35		

EXAMPLE

MGVM2048 S45 SB 3998 T00 - TWA101 - S2 - SR340

MMS VIP - SOFA 110" - ARMLESS

Five seater

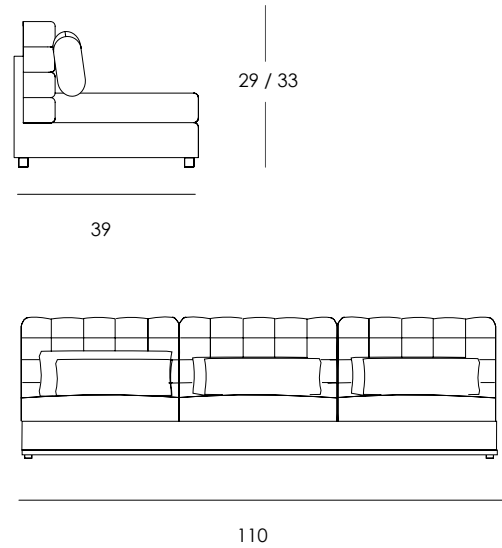

Specifications:

Frame:

Metallic anticorrosion painted, covered by polyether.
Available with MMS intelligent suspension system (with an upcharge)

Suspension:

Interlaced elastic webbing NEA

Cover:

Fixed upholstered

Seat:

Molded injected polyurethane upholstered with cotton casing

Back:

Molded injected polyurethane upholstered with cotton casing

Feet:

Oval metallic feet. Height 6 cm.

CODE	SEATER	ARMS	D	W	FABRIC	METAL	\$
MGVM2053	S5	SB	39	110	T00	S2	6,186
					T05		9,897
					T06		10,809
					T07		11,947
					T08		13,769
					T09		15,595
					T10		18,329
					T11		21,064
					T12		25,168
					T31		
					T32		
					T33		
					T34		
					T35		

EXAMPLE

MGVM2053 S5 SB 39110 T00 - TWA101 - S2 - SR340

MMS VIP - CHAISELOUNGE - RIGHT ARM

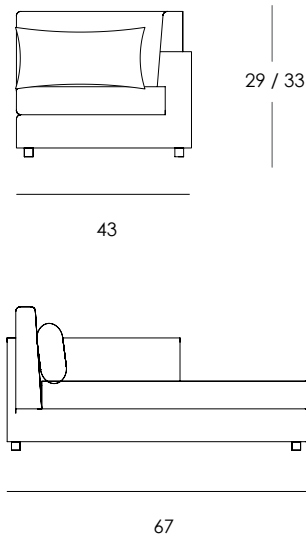

Specifications:

Frame:

Metallic anticorrosion painted, covered by polyether.
Available with MMS intelligent suspension system (with an upcharge)

Suspension:

Interlaced elastic webbing NEA

Cover:

Fixed upholstered

Seat:

Molded injected polyurethane upholstered with cotton casing

Back:

Molded injected polyurethane upholstered with cotton casing

Feet:

Oval metallic feet. Height 6 cm.

CODE	ARMS	D	W	FABRIC	METAL	\$
MGVM2070	BD	67	43	T00	S2	3,122
				T05		4,312
				T06		4,606
				T07		4,973
				T08		5,556
				T09		6,143
				T10		7,020
				T11		7,901
				T12		9,218
				T31		
				T32		
				T33		
				T34		
				T35		

EXAMPLE

MGVM2070 BD 6743 T00 - TWA101 - S2 - SR340

MMS VIP - CHAISELOUNGE - LEFT ARM

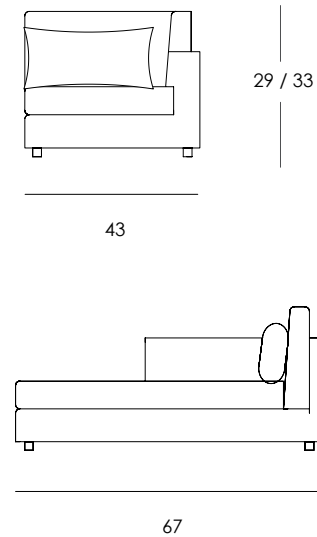

Specifications:

Frame:

Metallic anticorrosion painted, covered by polyether.
Available with MMS intelligent suspension system (with an upcharge)

Suspension:

Interlaced elastic webbing NEA

Cover:

Fixed upholstered

Seat:

Molded injected polyurethane upholstered with cotton casing

Back:

Molded injected polyurethane upholstered with cotton casing

Feet:

Oval metallic feet. Height 6 cm.

CODE	ARMS	D	W	FABRIC	METAL	\$
MGVM2071	BI	67	43	T00	S2	3,122
				T05		4,312
				T06		4,606
				T07		4,973
				T08		5,556
				T09		6,143
				T10		7,020
				T11		7,901
				T12		9,218
				T31		
				T32		
				T33		
				T34		
				T35		

EXAMPLE

MGVM2071 BI 6743 T00 - TWA101 - S2 - SR340

MMS VIP - CORNER CHAISELOUNGE

Right Arm

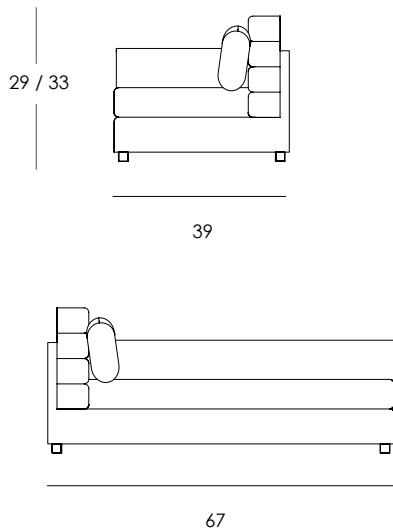

Specifications:

Frame:

Metallic anticorrosion painted, covered by polyether.
Available with MMS intelligent suspension system (with an upcharge)

Suspension:

Interlaced elastic webbing NEA

Cover:

Fixed upholstered

Seat:

Molded injected polyurethane upholstered with cotton casing

Back:

Molded injected polyurethane upholstered with cotton casing

Feet:

Oval metallic feet. Height 6 cm.

CODE	ARMS	D	W	FABRIC	METAL	\$
MGVM2075	BD	34	79	T00	S2	4,953
				T05		6,587
				T06		6,989
				T07		7,488
				T08		8,294
				T09		9,097
				T10		10,301
				T11		11,505
				T12		13,310
				T31		
				T32		
				T33		
				T34		
				T35		

EXAMPLE

MGVM2075 BD 3479 T00 - TWA101 - S2 - SR340

MMS VIP - CORNER CHAISELOUNGE

Left Arm

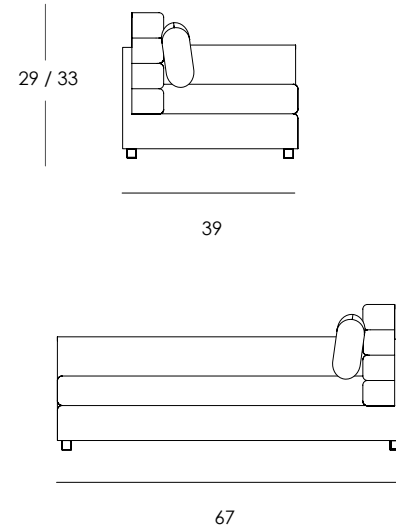

Specifications:

Frame:

Metallic anticorrosion painted, covered by polyether.
Available with MMS intelligent suspension system (with an upcharge)

Suspension:

Interlaced elastic webbing NEA

Cover:

Fixed upholstered

Seat:

Molded injected polyurethane upholstered with cotton casing

Back:

Molded injected polyurethane upholstered with cotton casing

Feet:

Oval metallic feet. Height 6 cm.

CODE	ARMS	D	W	FABRIC	METAL	\$
MGVM2076	BI	34	79	T00	S2	4,953
				T05		6,587
				T06		6,989
				T07		7,488
				T08		8,294
				T09		9,097
				T10		10,301
				T11		11,505
				T12		13,310
				T31		
				T32		
				T33		
				T34		
				T35		

EXAMPLE

MGVM2076 BI 3479 T00 - TWA101 - S2 - SR340

MMS VIP - RIGHT ARM

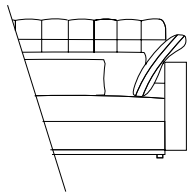

Specifications:

Wood covered by polyether.

CODE	ARMS	D	W	FABRIC	\$
MGVM2090	BD	39	10	T00	401
				T05	635
				T06	690
				T07	762
				T08	878
				T09	993
				T10	1,164
				T11	1,337
				T12	1,594
				T31	
				T32	
				T33	
				T34	
				T35	

EXAMPLE

MGVM2090 BD 3910 T00 - TWA101

MMS VIP - LEFT ARM

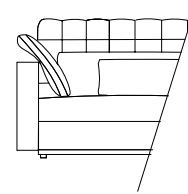

Specifications:

Wood covered by polyether.

CODE	ARMS	D	W	FABRIC	\$
MGVM2091	BI	39	10	T00	401
				T05	635
				T06	690
				T07	762
				T08	878
				T09	993
				T10	1,164
				T11	1,337
				T12	1,594
				T31	
				T32	
				T33	
				T34	
				T35	

EXAMPLE

MGVM2091 BI 3910 T00 - TWA101

MMS VIP - CORNER

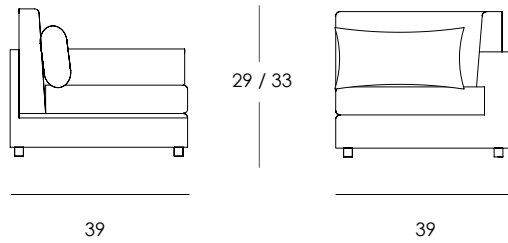

Specifications:

Frame:

Metallic anticorrosion painted, covered by polyether.
Available with MMS intelligent suspension system (with an upcharge)

Suspension:

Interlaced elastic webbing NEA

Cover:

Fixed upholstered

Seat:

Molded injected polyurethane upholstered with cotton casing

Back:

Molded injected polyurethane upholstered with cotton casing

Feet:

Oval metallic feet. Height 6 cm.

CODE	D	W	FABRIC	METAL	\$
MGVM2050	39	39	T00	S2	2,720
			T05		3,815
			T06		4,083
			T07		4,418
			T08		4,956
			T09		5,493
			T10		6,298
			T11		7,104
			T12		8,314
			T31		
			T32		
			T33		
			T34		
			T35		

EXAMPLE

MGVM2050 3939 T00 - TWA101 - S2 - SR340

MMS VIP - CORNER RIGHT ARM

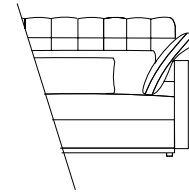

Specifications:

Wood covered by polyether.

CODE	ARMS	D	W	FABRIC	\$
MGVM2092	BD	39	4	T00	352
				T05	549
				T06	595
				T07	656
				T08	754
				T09	849
				T10	993
				T11	1,141
				T12	1,357
				T31	
				T32	
				T33	
				T34	
				T35	

EXAMPLE

MGVM2092 BD 394 T00 - TWA101

MMS VIP - CORNER LEFT ARM

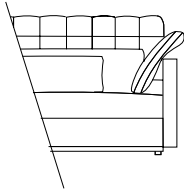

Specifications:

Wood covered by polyether.

CODE	ARMS	D	W	FABRIC	\$
MGVM2093	BI	39	4	T00	352
				T05	549
				T06	595
				T07	656
				T08	754
				T09	849
				T10	993
				T11	1,141
				T12	1,357
				T31	
				T32	
				T33	
				T34	
				T35	

EXAMPLE

MGVM2093 BI 394 T00 - TWA101

CODE

\$

CODE

\$

